



COMPLEMENTED WITH TRENO TABLES

LAGUNA TABLE OF CONTENTS

Laguna Specifications	2
Laguna Standard Back vs Inset Back	3
Laguna Banquettes Options	4
Laguna Banquettes Pricing	5
Laguna Banquettes Privacy Panels	6
Laguna Modular Options	7
Laguna Modular Pricing	9
Laguna Modular Privacy Panels	13
Laguna Modular Arms	17
Laguna Modular Quattro Pricing	21
Laguna Lounge Options.....	22
Laguna Lounge Pricing.....	23
Laguna Lounge Hideout Pricing	24
Laguna Bolster & Pillows	26
Laguna Bench Pricing.....	27
Laguna Ottomans Pricing	28
Laguna Tables	32
Laguna Configurations	36

LAGUNA

The Laguna collection consists of variety of pieces that comprise of banquettes, modular units, lounges, benches, ottomans and tables. A very versatile lounge and modular system that will enhance any space or public environment with numerous options to customize the look. Laguna allows for private seating arrangements using our Hideout lounge or privacy panels on the modular units. Great for common areas, cafes and lobbies with an array of options and finishes for a truly American visionary design.



BANQUETTES



MODULAR



MODULAR - QUATTRO



LOUNGE - HIDEOUT



LOUNGE



BENCH



OTTOMAN



OCCASIONAL TABLE

ORDERING INFORMATION

- | | |
|----------------------------|----------------------------------|
| 1) Series Name | 5) Powder Coat Color for legs |
| 2) Model Number | 6) Panel Laminate/Edge Selection |
| 3) Quantity | 7) Optional Items |
| 4) Fabric Grade and Number | 8) Optional Wood Stain Color |

SOFT SEATING	WEIGHT LIMIT
1 Seat	500 lbs.
2 Seat	1000 lbs.
3 Seat	1500 lbs.

STANDARD BASE FINISHES

Legs: Standard Powder Coat

STANDARD POWDER COAT METAL LEG



GENERAL SPECIFICATIONS

Frame Construction

- Multi-ply hardwood
- Tongue and groove construction nailed and glued

Seat/Foam

- No-sag springs w/ helicoil attachment
- High resiliency foam construction throughout
- All foam bonded to frame

Upholstery

Seat and back are covered in choice of fabric, vinyl, crypton, leather or COM. ERG uses only water based glues and adhesives in our upholstery process.

Legs

- 8" tall, 1.5" diameter fabricated steel angeled legs
- Sand blasted prior to paint for maximum color adhesion
- Includes factory installed adjustable glides

Note for Edge of privacy panels:

- Straight panels: available with 3MM PVC or laminate self edge. Select from any of our 3MM PVC edges in solid or wood tone, no custom colors available.
- Curved panels: will only able available with laminate self edge.
- Both straight and curved panels: when combining straight panels and curved panels, ONLY self edge is available.

STANDARD BACK

OPTIONAL INSET BACK

BACK IS INSET 2" ON EACH SIDE



STRAIGHT UNIT

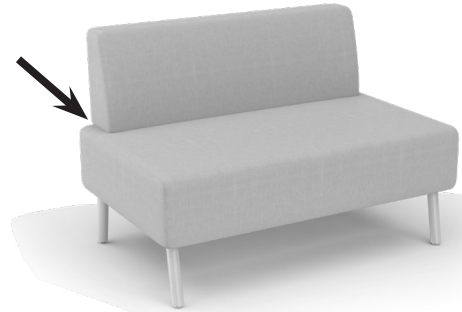

OUTSIDE CURVE



INSIDE CURVE



STRAIGHT PRIVACY
PANEL



OPTIONS

- CODE: FR - CAL 133 (TB 133) Fire Retardant
- CODE: MB - Moisture Barrier (up to 60" overall width)
- CODE: MB60 - Moisture Barrier (over 60" overall width)
- CODE: PC - Polished Chrome Legs
- CODE: WDL - Metal/Wood Legs. (Specify powder coat and wood color)
- CODE: WDL-C - Chrome/Wood Legs. (Specify wood color)
- CODE: 2FO - Two Fabric Option
- CODE: 3FO - Three Fabric Option
- CODE: GD1 - Ratchet Ganging Device for Soft Seating
- CODE: ISB - Inset Back

Note: Factory installed power/data available, see accessories online under the 'Products' tab.



SHOWN WITH 3FORM ACRYLIC PRIVACY PANEL, POWER/DATA AND METAL/WOOD LEGS

Laguna Leg Options



2 TONE FABRIC

OPTIONAL METAL/WOOD LEG
CODE: WDL



OPTIONAL CHROME LEG
CODE: PC



OPTIONAL CHROME/WOOD LEG
CODE: WDL-C



DIMENSIONS	48" Straight	60" Straight	72" Straight	Corner Unit
Seat Depth:	21"	21"	21"	21"
Seat Width:	48"	60"	72"	21"
Seat Height:	18"	18"	18"	18"
Overall Depth:	27"	27"	27"	27"
Overall Width:	48"	60"	72"	27"
Overall Height:	30"	30"	30"	30"
Qty./Wt.:	1 ea./75 lbs.	1 ea./90 lbs.	1 ea./110 lbs.	1 ea./58 lbs.



60" W STRAIGHT UNIT

MODEL / DESCRIPTION / LIST PRICING



1206 48" W Straight (4 legs)

COM Yardage: Total: 5.25 Yds. / Back: 2.5 Yds. / Seat: 2.75 Yds.

COM	GR1	GR2	GR3	GR4	GR5	GR6	GR7	GR8	GR9	GR10	LEA
\$3298	\$3492	\$3684	\$3876	\$4066	\$4260	\$4452	\$4645	\$4838	\$5029	\$5224	\$5408



1208 60" W Straight (4 legs)

COM Yardage: Total: 6.5 Yds. / Back: 3 Yds. / Seat: 3.5 Yds.

COM	GR1	GR2	GR3	GR4	GR5	GR6	GR7	GR8	GR9	GR10	LEA
\$4279	\$4523	\$4712	\$4904	\$5096	\$5289	\$5481	\$5675	\$5864	\$6060	\$6253	\$6435



1210 72" W Straight (6 legs)

COM Yardage: Total: 7.5 Yds. / Back: 3.5 Yds. / Seat: 4 Yds.

COM	GR1	GR2	GR3	GR4	GR5	GR6	GR7	GR8	GR9	GR10	LEA
\$4790	\$5029	\$5224	\$5414	\$5607	\$5799	\$5991	\$6183	\$6377	\$6568	\$6763	\$6946



1211 Corner Unit (4 Legs)

COM Yardage: Total: 4.25 Yds. / Back: 2 Yds. / Seat: 2.25 Yds.

COM	GR1	GR2	GR3	GR4	GR5	GR6	GR7	GR8	GR9	GR10	LEA
\$3296	\$3473	\$3636	\$3808	\$3970	\$4147	\$4322	\$4499	\$4674	\$4852	\$5025	\$5211

Note: For back-to-back applications please order two units.

OPTIONS

Add upcharge to list price and code to model number

FR	CAL 133 (TB 133) Fire Retardant per yard	\$118	/yd.
MB	Moisture Barrier (up to 60" overall width)	\$164	ea.
MB60	Moisture Barrier (over 60" overall width)	\$262	ea.
WDL	Metal/Wood Legs	\$45	ea.
WDL-C	Chrome/Wood Legs	\$79	ea.

PC	Polished Chrome Legs	\$45	ea.
2FO	Two Fabric Option	\$131	
GD1	Ratchet Ganging Device for Soft Seating	\$112	per pair
ISB	Inset Back (Add to Standard Unit)	\$66	

PRIVACY PANELS ONLY

DIMENSIONS	48" Wide Privacy Panel	60" Wide Privacy Panel	72" Wide Privacy Panel
Panel Depth:	1"	1"	1"
Panel Width:	48"	60"	72"
Panel Height:	48"	48"	48"
Qty./Approx Wt.:	1 ea./100 lbs.	1 ea./110 lbs.	1 ea./120 lbs.



LAGUNA BANQUETTE
WITH PRIVACY PANEL



1/2" THICK ACRYLIC
PRIVACY PANELS AVAILABLE

MODEL / DESCRIPTION / LIST PRICING

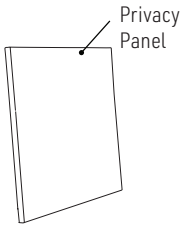

1206P 48" W Privacy Panel

COM Yardage: Total: 3 Yds. (Please allow extra fabric for repeat design.)

COM	GR1	GR2	GR3	GR4	GR5	GR6	GR7	GR8	GR9	GR10	LEA
\$1435	\$1536	\$1595	\$1661	\$1726	\$1796	\$1867	\$1941	\$2019	\$2100	\$2183	\$2580
LAMINATE			VENEER			ACRYLIC					
\$1405			\$2559			CALL					

1208P 60" W Privacy Panel

COM Yardage: Total: 4 Yds. (Please allow extra fabric for repeat design.)

COM	GR1	GR2	GR3	GR4	GR5	GR6	GR7	GR8	GR9	GR10	LEA
\$1892	\$2026	\$2104	\$2189	\$2277	\$2367	\$2459	\$2562	\$2663	\$2770	\$2881	\$3407
LAMINATE			VENEER			ACRYLIC					
\$1839			\$3291			CALL					

1210P 72" W Privacy Panel

COM Yardage: Total: 5 Yds. (Please allow extra fabric for repeat design.)

COM	GR1	GR2	GR3	GR4	GR5	GR6	GR7	GR8	GR9	GR10	LEA
\$2315	\$2478	\$2577	\$2682	\$2788	\$2899	\$3017	\$3137	\$3262	\$3391	\$3526	\$4170
LAMINATE			VENEER			ACRYLIC					
\$2233			\$3864			CALL					

Note for Edge of privacy panels:

- Straight panels: available with 3MM PVC or laminate self edge.
Select from any of our 3MM PVC edges in solid or wood tone, no custom colors available.
- Curved panels: will only be available with laminate self edge.
- Both straight and curved panels: when combining straights and curved, ONLY self edge is available.

OPTIONS

- CODE: FR - CAL 133 (TB 133) Fire Retardant
- CODE: MB - Moisture Barrier (up to 60" overall width)
- CODE: MB60 - Moisture Barrier (over 60" overall width)
- CODE: PC - Polished Chrome Legs
- CODE: WDL - Metal/Wood Legs. (Specify powder coat and wood color)
- CODE: WDL-C - Chrome/Wood Legs. (Specify wood color)
- CODE: CAS2 - 2" Locking Casters - Black
- CODE: AS3 - 3" Locking Casters - Black
- CODE: 2FO - Two Fabric Option
- CODE: 3FO - Three Fabric Option
- CODE: GD1 - Ratchet Ganging Device for Soft Seating
- CODE: FMG - Floor Mount Glide
- CODE: TABF-() - Fixed Post Tablet
(outside, specify (L/R), shape A, B or C)

- CODE: TABFB-() - Fixed Blade Tablet
(outside or inside, specify (L/R), shape A, B or C)
- CODE: TABR1-() - Removable Tablet (shape A, B or C, left or right arm)
- CODE: TABR2-() - Removable Tablet (shape A, B or C, hardware both arms)
- CODE: LAM5 - Non-standard laminate for 5 or less tablets
see options for upcharge
- CODE: SST - Solid Surface Tablet
- CODE: SS5 - Non-standard Solid Surface top for 5 or less tablets
- CODE: BWAC - Wood Arm Cap (Box Arm)
- CODE: WAC - Wood Arm Caps
- CODE: PAC - Poly Arm Caps
- CODE: ISB - Inset Back

Note: Factory installed power/data available, see accessories online under the 'Products' tab.



MODULAR - QUATTRO



CURVED PRIVACY PANEL



60° BACKLESS INSIDE CURVE



30° OUTSIDE CURVE



2 TONE FABRIC

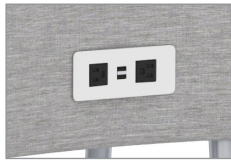

POWER/DATA

Note: Factory installed power/data available, see accessories online under the 'Products' tab.



WOOD ARM CAPS
(BOX ARMS)



WOOD ARM CAPS
(SLIM ARMS)

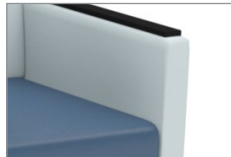

POLY ARM CAPS
(SLIM ARMS ONLY)

Laguna Leg Options

OPTIONAL METAL/WOOD LEG
CODE: WDL



OPTIONAL CHROME LEG
CODE: PC



OPTIONAL CHROME/WOOD LEG
CODE: WDL-C



TABLET SHAPES

Three Tablet Shapes::

Choose from the three shapes shown and specify; A, B or C and left or right (outside tablet) when ordering.
Example: TABFB-(A) Left - this would be a fixed shape A tablet on the left side (when seated).

Laminate Top: Tops are 3/4"

Tablet orders of 5 or less have 4 standard laminate colors:

- Wilsonart Black 1595-60
- Wilsonart Montana Walnut 7110K-78
- Formica Brite White 459-58
- Nevamar Silver Alu Metalx MXT003

Edge: 6F Multi-Ply

Solid Surface Top:

Tablet orders of 5 or less have 4 standard Corian colors:
• Bone • Canyon • Glacier White • Silver Grey

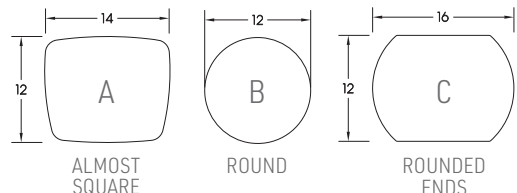

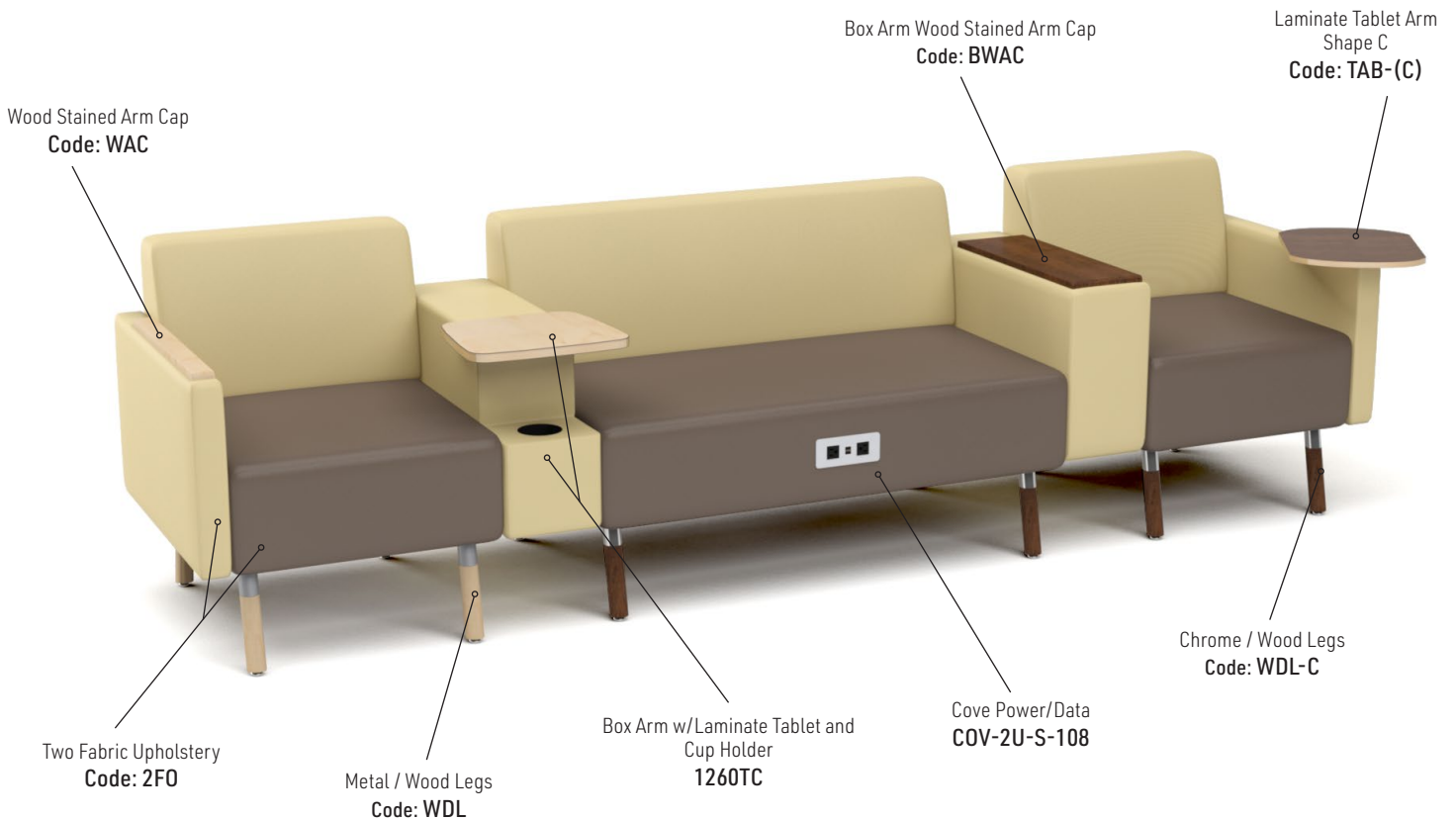
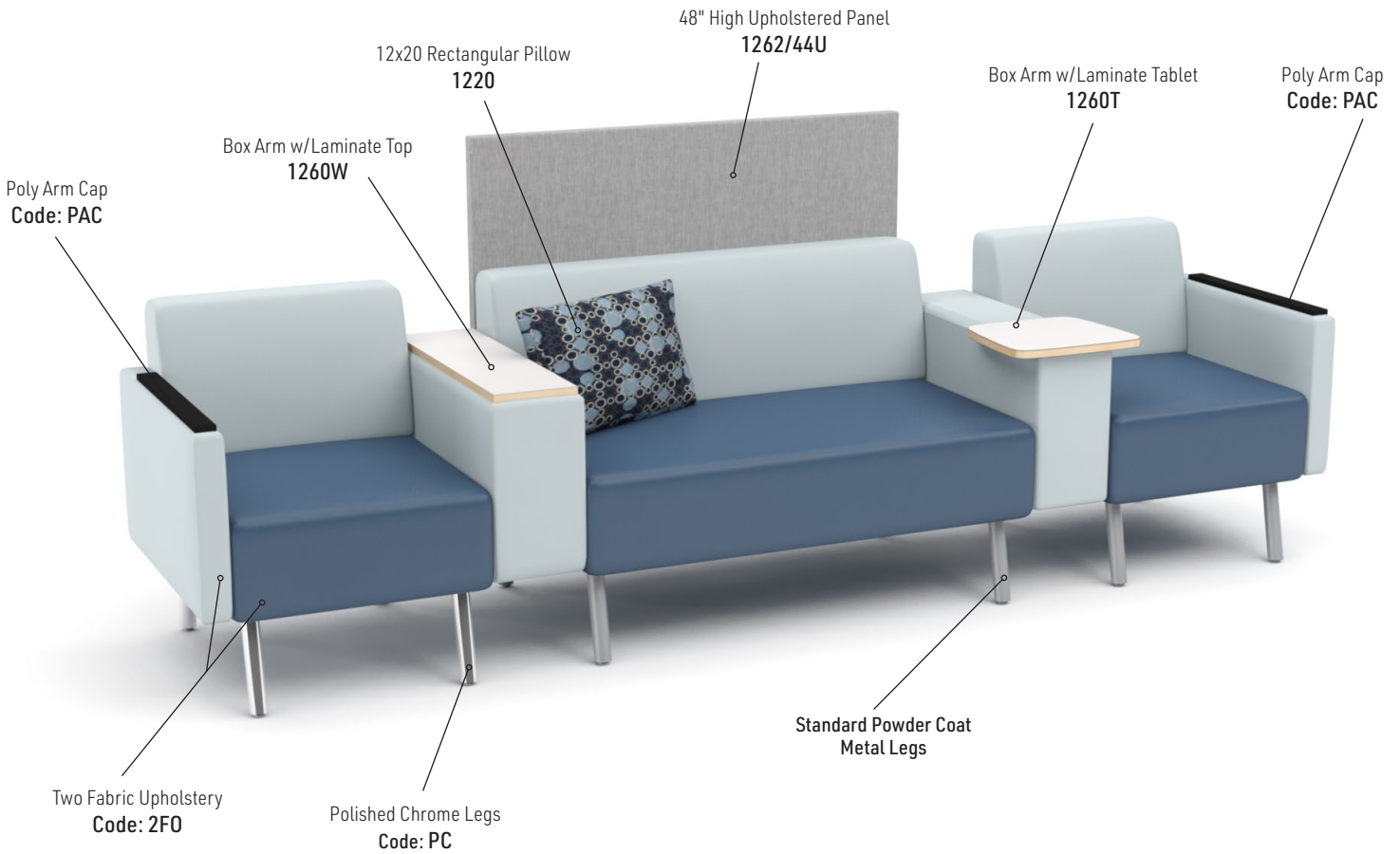

DIMENSIONS	22" Straight	30" Straight	44" Straight	Corner Unit
Seat Depth:	21"	21"	21"	21"
Seat Width:	22"	30"	44"	21"
Seat Height:	17"	17"	17"	17"
Overall Depth:	27"	27"	27"	27"
Overall Width:	22"	30"	44"	27"
Overall Height:	30"	30"	30"	30"
Qty./Wt.:	1 ea./58 lbs.	1 ea./68 lbs.	1 ea./85 lbs.	1 ea./58 lbs.



STRAIGHT UNIT WITH OPTIONAL METAL/WOOD LEGS



CORNER UNIT WITH OPTIONAL METAL/WOOD LEGS

MODEL / DESCRIPTION / LIST PRICING



1200 22" W Straight Units (4 Legs)

COM Yardage: Total: 3 Yds. / Back: 1.5 Yds. / Seat: 1.5 Yds.

COM	GR1	GR2	GR3	GR4	GR5	GR6	GR7	GR8	GR9	GR10	LEA
\$1963	\$2073	\$2187	\$2315	\$2428	\$2555	\$2684	\$2812	\$2940	\$3068	\$3197	\$3381



1202 30" W Straight Units (4 Legs)

COM Yardage: Total: 4 Yds. / Back: 1.75 Yds. / Seat: 2.25 Yds.

COM	GR1	GR2	GR3	GR4	GR5	GR6	GR7	GR8	GR9	GR10	LEA
\$2286	\$2422	\$2565	\$2727	\$2872	\$3032	\$3192	\$3352	\$3512	\$3671	\$3866	\$4048



1204 44" W Straight Units (4 Legs)

COM Yardage: Total: 4.5 Yds. / Back: 2 Yds. / Seat: 2.5 Yds.

COM	GR1	GR2	GR3	GR4	GR5	GR6	GR7	GR8	GR9	GR10	LEA
\$3203	\$3394	\$3587	\$3780	\$3972	\$4166	\$4358	\$4550	\$4742	\$4933	\$5126	\$5313



1218 Corner Unit (4 Legs)

COM Yardage: Total: 4.25 Yds. / Back: 2 Yds. / Seat: 2.25 Yds.

COM	GR1	GR2	GR3	GR4	GR5	GR6	GR7	GR8	GR9	GR10	LEA
\$3296	\$3473	\$3636	\$3808	\$3970	\$4147	\$4322	\$4499	\$4674	\$4852	\$5025	\$5211

OPTIONS

Add upcharge to list price and code to model number

FR	CAL 133 (TB 133) Fire Retardant per yard	\$118	/yd.	GD1	Ratchet Ganging Device for Soft Seating	\$112	per pair
MB	Moisture Barrier (up to 60" overall width)	\$164	ea.	TABFB-()	Fixed Blade Tablet (outside or inside, specify (L/R), shape A, B or C)	\$593	ea. tablet
WDL	Metal/Wood Legs	\$45	ea.	LAM5	Non-standard laminate (5 tablets or less)	\$554	ea. tablet
WDL-C	Chrome/Wood Legs	\$79	ea.	SST	Solid Surface Tablet Arm - add to tablet option	\$271	ea. tablet
PC	Polished Chrome Legs	\$45	ea.	SS5	Non-standard Solid Surface (5 tablets or less)	Call For Quote	
2FO	Two Fabric Option	\$131		ISB	Inset Back (Add to Standard Unit)	\$66	

DIMENSIONS	30° Inside Curve	30° Outside Curve
Seat Depth:	21"	21"
Seat Width:	17"	31"
Seat Height:	17"	17"
Overall Depth:	27"/28"	27"/28"
Overall Width:	17"/31"	17"/31"
Overall Height:	30"	30"
Qty./Wt.:	1 ea./58 lbs.	1 ea./68 lbs.



INSIDE CURVE UNIT WITH
OPTIONAL METAL/WOOD LEGS

MODEL / DESCRIPTION / LIST PRICING



1212 Inside 30° Curve Unit (4 Legs)

COM Yardage: Total: 4 Yds. / Back: 2 Yds. / Seat: 2 Yds.

COM	GR1	GR2	GR3	GR4	GR5	GR6	GR7	GR8	GR9	GR10	LEA
\$1973	\$2080	\$2186	\$2306	\$2414	\$2534	\$2654	\$2774	\$2895	\$3019	\$3139	\$3311



1213 Outside 30° Curve Unit (4 Legs)

COM Yardage: Total: 3.5 Yds. / Back: 1.5 Yds. / Seat: 2 Yds.

COM	GR1	GR2	GR3	GR4	GR5	GR6	GR7	GR8	GR9	GR10	LEA
\$2086	\$2208	\$2314	\$2435	\$2542	\$2661	\$2783	\$2903	\$3024	\$3144	\$3267	\$3441

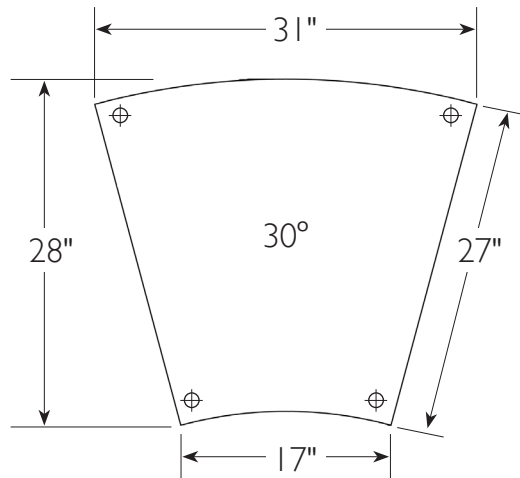

OPTIONS

Add upcharge to list price and code to model number

FR	CAL 133 (TB 133) Fire Retardant per yard	\$118	/yd.
MB	Moisture Barrier (up to 60" overall width)	\$164	ea.
WDL	Metal/Wood Legs	\$45	ea.
WDL-C	Chrome/Wood Legs	\$79	ea.
PC	Polished Chrome Legs	\$45	ea.
2FO	Two Fabric Option	\$131	

GD1	Ratchet Ganging Device for Soft Seating	\$112	per pair
TABFB- ()	Fixed Blade Tablet (outside or inside, specify (L/R), shape A, B or C)	\$593	ea. tablet
LAM5	Non-standard laminate (5 tablets or less)	\$554	ea. tablet
SST	Solid Surface Tablet Arm - add to tablet option	\$271	ea. tablet
SS5	Non-standard Solid Surface (5 tablets or less)	Call For Quote	
ISB	Inset Back (Add to Standard Unit)	\$66	

DIMENSIONS	45° Inside Curve	45° Outside Curve
Seat Depth:	21"	21"
Seat Width:	25"	46"
Seat Height:	17"	17"
Overall Depth:	27"/29.5"	27"/29.5"
Overall Width:	25.25"/46"	25.25"/46"
Overall Height:	30"	30"
Qty./Wt.:	1 ea./58 lbs.	1 ea./68 lbs.



INSIDE CURVE UNIT WITH
OPTIONAL METAL/WOOD LEGS

MODEL / DESCRIPTION / LIST PRICING



1214 Inside 45° Curve (4 Legs)

COM Yardage: Total: 5.5 Yds. / Back: 2.5 Yds. / Seat: 3 Yds.

COM	GR1	GR2	GR3	GR4	GR5	GR6	GR7	GR8	GR9	GR10	LEA
\$3096	\$3260	\$3417	\$3594	\$3756	\$3930	\$4108	\$4282	\$4459	\$4635	\$4811	\$4997



1215 Outside 45° Curve (4 Legs)

COM Yardage: Total: 5.25 Yds. / Back: 2.25 Yds. / Seat: 3 Yds.

COM	GR1	GR2	GR3	GR4	GR5	GR6	GR7	GR8	GR9	GR10	LEA
\$3453	\$3615	\$3776	\$3952	\$4111	\$4290	\$4466	\$4642	\$4816	\$4994	\$5170	\$5354

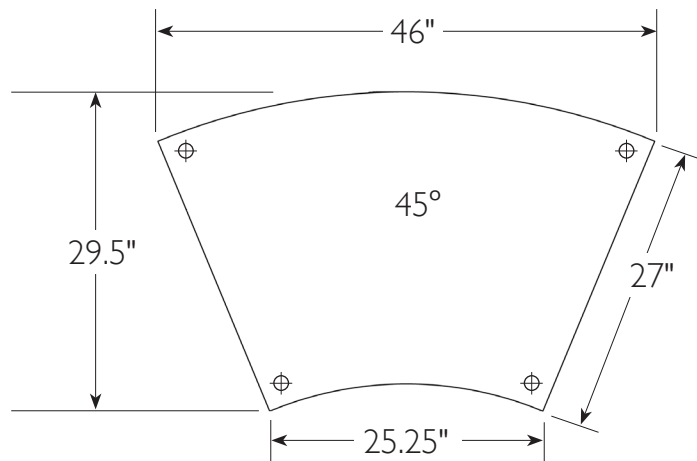

OPTIONS

Add upcharge to list price and code to model number

FR	CAL 133 (TB 133) Fire Retardant per yard	\$118	/yd.
MB	Moisture Barrier (up to 60" overall width)	\$164	ea.
WDL	Metal/Wood Legs	\$45	ea.
WDL-C	Chrome/Wood Legs	\$79	ea.
PC	Polished Chrome Legs	\$45	ea.
2FO	Two Fabric Option	\$131	

GD1	Ratchet Ganging Device for Soft Seating	\$112	per pair
TABFB-(L)	Fixed Blade Tablet (outside or inside, specify (L/R), shape A, B or C)	\$593	ea. tablet
LAM5	Non-standard laminate (5 tablets or less)	\$554	ea. tablet
SST	Solid Surface Tablet Arm - add to tablet option	\$271	ea. tablet
SS5	Non-standard Solid Surface (5 tablets or less)	Call For Quote	
ISB	Inset Back (Add to Standard Unit)	\$66	

DIMENSIONS	60° Inside Curve	60° Outside Curve
Seat Depth:	21"	21"
Seat Width:	33"	60"
Seat Height:	17"	17"
Overall Depth:	27"/31.5"	27"/31.5"
Overall Width:	33"/60"	33"/60"
Overall Height:	30"	30"
Qty./Wt.:	1 ea./58 lbs.	1 ea./68 lbs.



INSIDE CURVE UNIT WITH
OPTIONAL METAL/WOOD LEGS

MODEL / DESCRIPTION / LIST PRICING



1216 Inside 60° Curve (5 legs)

COM Yardage: Total: 7 Yds. / Back: 3 Yds. / Seat: 4 Yds.

COM	GR1	GR2	GR3	GR4	GR5	GR6	GR7	GR8	GR9	GR10	LEA
\$3300	\$3463	\$3621	\$3798	\$3960	\$4135	\$4312	\$4488	\$4666	\$4840	\$5019	\$5202

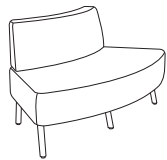

1217 Outside 60° Curve (5 legs)

COM Yardage: Total: 6.5 Yds. / Back: 2.5 Yds. / Seat: 4 Yds.

COM	GR1	GR2	GR3	GR4	GR5	GR6	GR7	GR8	GR9	GR10	LEA
\$3485	\$3663	\$3823	\$3997	\$4156	\$4333	\$4508	\$4686	\$4862	\$5039	\$5214	\$5401

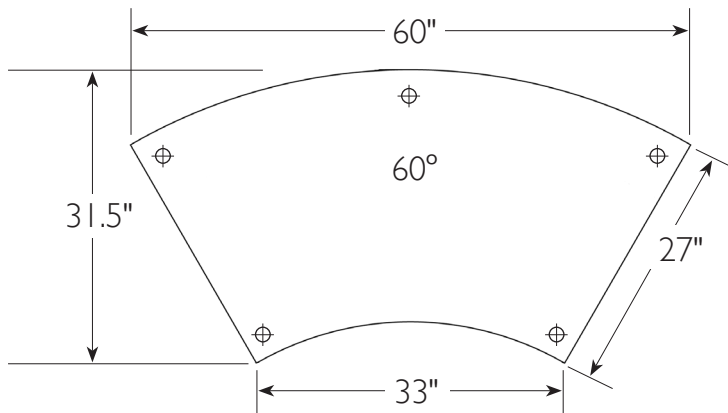

OPTIONS

Add upcharge to list price and code to model number

FR	CAL 133 (TB 133) Fire Retardant per yard	\$118	/yd.	GD1	Ratchet Ganging Device for Soft Seating	\$112	per pair
MB	Moisture Barrier (up to 60" overall width)	\$164	ea.	TABFB-(L)	Fixed Blade Tablet (outside or inside, specify (L/R), shape A, B or C)	\$593	ea. tablet
WDL	Metal/Wood Legs	\$45	ea.	LAM5	Non-standard laminate (5 tablets or less)	\$554	ea. tablet
WDL-C	Chrome/Wood Legs	\$79	ea.	SST	Solid Surface Tablet Arm - add to tablet option	\$271	ea. tablet
PC	Polished Chrome Legs	\$45	ea.	SS5	Non-standard Solid Surface (5 tablets or less)	Call For Quote	
2FO	Two Fabric Option	\$131		ISB	Inset Back (Add to Standard Unit)	\$66	

DIMENSIONS	Straight Panel	Straight Panel	Straight Panel
Panel Depth:	1"	1"	1"
Overall Width:	22"	30"	44"
Overall Height:	48"	48"	48"
Qty./Approx Wt.:	1 ea./100 lbs.	1 ea./110 lbs.	1 ea./120 lbs.

Note: For Laminate or Acrylic, please call for quote.



STRAIGHT PRIVACY PANEL

MODEL / DESCRIPTION / LIST PRICING

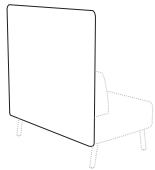

1262/22U 22" Straight Panel - Upholstered

COM Yardage - Panel: 1.5 Yds.

COM	GR1	GR2	GR3	GR4	GR5	GR6	GR7	GR8	GR9	GR10	LEA
\$941	\$1007	\$1050	\$1093	\$1135	\$1180	\$1229	\$1275	\$1326	\$1379	\$1436	\$1699

1262/30U 30" Straight Panel - Upholstered

COM Yardage - Panel: 2 Yds.

COM	GR1	GR2	GR3	GR4	GR5	GR6	GR7	GR8	GR9	GR10	LEA
\$1169	\$1250	\$1300	\$1348	\$1408	\$1460	\$1520	\$1582	\$1643	\$1708	\$1778	\$2100

1262/44U 44" Straight Panel - Upholstered

COM Yardage - Panel: 2.5 Yds.

COM	GR1	GR2	GR3	GR4	GR5	GR6	GR7	GR8	GR9	GR10	LEA
\$1342	\$1436	\$1491	\$1554	\$1613	\$1680	\$1747	\$1817	\$1890	\$1965	\$2045	\$2415

OPTIONS

Add upcharge to list price and code to model number

FR	CAL 133 (TB 133) Fire Retardant per yard	\$118	/yd.	2FO	Two Fabric Option	\$131	
----	--	-------	------	-----	-------------------	-------	--

DIMENSIONS	Inset Straight Panel	Inset Straight Panel	Inset Straight Panel
Panel Depth:	1"	1"	1"
Overall Width:	18"	26"	40"
Overall Height:	48"	48"	48"
Qty./Approx Wt.:	1 ea./100 lbs.	1 ea./110 lbs.	1 ea./120 lbs.

Note: Upholstered panels are 1.0" thick.
For Laminate or Acrylic, please call for quote.



INSET STRAIGHT PRIVACY PANEL

MODEL / DESCRIPTION / LIST PRICING

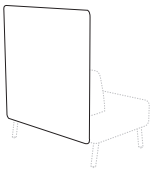

1263/18U Inset 18" Inset Straight Panel - Upholstered

COM Yardage - Panel: 1.5 Yds.

COM	GR1	GR2	GR3	GR4	GR5	GR6	GR7	GR8	GR9	GR10	LEA
\$1028	\$1093	\$1132	\$1176	\$1218	\$1264	\$1311	\$1360	\$1410	\$1462	\$1519	\$1780

1263/26U Inset 26" Inset Straight Panel - Upholstered

COM Yardage - Panel: 2 Yds.

COM	GR1	GR2	GR3	GR4	GR5	GR6	GR7	GR8	GR9	GR10	LEA
\$1250	\$1332	\$1383	\$1432	\$1489	\$1541	\$1602	\$1664	\$1726	\$1791	\$1861	\$2183

1263/40U Inset 40" Inset Straight Panel - Upholstered

COM Yardage - Panel: 2.5 Yds.

COM	GR1	GR2	GR3	GR4	GR5	GR6	GR7	GR8	GR9	GR10	LEA
\$1425	\$1519	\$1575	\$1635	\$1697	\$1762	\$1827	\$1901	\$1973	\$2048	\$2127	\$2496

OPTIONS

Add upcharge to list price and code to model number

FR	CAL 133 (TB 133) Fire Retardant per yard	\$118	/yd.	2FO	Two Fabric Option	\$131	
----	--	-------	------	-----	-------------------	-------	--

DIMENSIONS	Inside Curve Panel	Inside Curve Panel	Inside Curve Panel
Panel Depth:	1"	1"	1"
Overall Width:	31"	46"	60"
Overall Height:	48"	48"	48"
Qty./Approx Wt.:	1 ea./100 lbs.	1 ea./110 lbs.	1 ea./120 lbs.

DIMENSIONS	Outside Curve Panel	Outside Curve Panel	Outside Curve Panel
Panel Depth:	1"	1"	1"
Overall Width:	17"	25"	33"
Overall Height:	48"	48"	48"
Qty./Approx Wt.:	1 ea./100 lbs.	1 ea./110 lbs.	1 ea./120 lbs.



45° INSIDE CURVE PRIVACY PANEL

45° OUTSIDE CURVE PANEL

Note: Upholstered panels are 1.0" thick.
For Laminate or Acrylic, please call for quote.

MODEL / DESCRIPTION / LIST PRICING

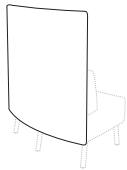

1270/30U 30° Inside Curve Panel - Upholstered

COM Yardage - Panel: 2 Yds.

COM	GR1	GR2	GR3	GR4	GR5	GR6	GR7	GR8	GR9	GR10	LEA
\$1752	\$1871	\$1944	\$2026	\$2107	\$2190	\$2278	\$2368	\$2466	\$2562	\$2664	\$3151

1270/45U 45° Inside Curve Panel - Upholstered

COM Yardage - Panel: 3 Yds.

COM	GR1	GR2	GR3	GR4	GR5	GR6	GR7	GR8	GR9	GR10	LEA
\$2015	\$2156	\$2239	\$2328	\$2423	\$2521	\$2622	\$2726	\$2834	\$2948	\$3062	\$3623

1270/60U 60° Inside Curve Panel - Upholstered

COM Yardage - Panel: 4 Yds.

COM	GR1	GR2	GR3	GR4	GR5	GR6	GR7	GR8	GR9	GR10	LEA
\$3143	\$3362	\$3498	\$3639	\$3781	\$3934	\$4089	\$4256	\$4423	\$4604	\$4786	\$5658

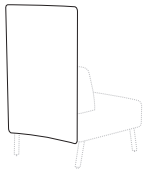

1272/30U 30° Outside Curve Panel - Upholstered

COM Yardage - Panel: 2 Yds.

COM	GR1	GR2	GR3	GR4	GR5	GR6	GR7	GR8	GR9	GR10	LEA
\$1489	\$1591	\$1655	\$1721	\$1790	\$1863	\$1938	\$2015	\$2095	\$2177	\$2265	\$2680

1272/45U 45° Outside Curve Panel - Upholstered

COM Yardage - Panel: 3 Yds.

COM	GR1	GR2	GR3	GR4	GR5	GR6	GR7	GR8	GR9	GR10	LEA
\$1712	\$1832	\$1905	\$1978	\$2063	\$2140	\$2230	\$2315	\$2406	\$2506	\$2601	\$3078

1272/60U 60° Outside Curve Panel - Upholstered

COM Yardage - Panel: 4 Yds.

COM	GR1	GR2	GR3	GR4	GR5	GR6	GR7	GR8	GR9	GR10	LEA
\$2670	\$2857	\$2973	\$3093	\$3216	\$3342	\$3479	\$3619	\$3761	\$3909	\$4071	\$4807

OPTIONS

Add upcharge to list price and code to model number

FR	CAL 133 (TB 133) Fire Retardant per yard	\$118	/yd.	2FO	Two Fabric Option	\$131	
----	--	-------	------	-----	-------------------	-------	--

DIMENSIONS	Inset Inside Curve Panel	Inset Inside Curve Panel	Inset Inside Curve Panel
Panel Depth:	1"	1"	1"
Overall Width:	27"	42"	56"
Overall Height:	48"	48"	48"
Qty./Wt.:	1 ea./100 lbs.	1 ea./110 lbs.	1 ea./120 lbs.

DIMENSIONS	Inset Outside Curve Panel	Inset Outside Curve Panel	Inset Outside Curve Panel
Panel Depth:	1"	1"	1"
Overall Width:	13"	21"	29"
Overall Height:	48"	48"	48"
Qty./Wt.:	1 ea./100 lbs.	1 ea./110 lbs.	1 ea./120 lbs.

Note: Upholstered panels are 1.0" thick.
For Laminate or Acrylic, please call for quote.



INSET INSIDE CURVE PRIVACY PANEL



INSET OUTSIDE CURVE PRIVACY PANEL

MODEL / DESCRIPTION / LIST PRICING

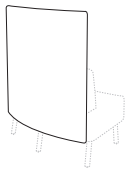

1271/30U Inset 30° Inside Curve Panel - Upholstered

COM Yardage - Panel: 2 Yds.

COM	GR1	GR2	GR3	GR4	GR5	GR6	GR7	GR8	GR9	GR10	LEA
\$1833	\$1955	\$2028	\$2108	\$2186	\$2274	\$2361	\$2452	\$2548	\$2642	\$2748	\$3233

1271/45U Inset 45° Inside Curve Panel - Upholstered

COM Yardage - Panel: 3 Yds.

COM	GR1	GR2	GR3	GR4	GR5	GR6	GR7	GR8	GR9	GR10	LEA
\$2095	\$2237	\$2324	\$2412	\$2506	\$2600	\$2705	\$2809	\$2913	\$3029	\$3147	\$3704

1271/60U Inset 60° Inside Curve Panel - Upholstered

COM Yardage - Panel: 4 Yds.

COM	GR1	GR2	GR3	GR4	GR5	GR6	GR7	GR8	GR9	GR10	LEA
\$3225	\$3444	\$3578	\$3721	\$3866	\$4015	\$4173	\$4339	\$4506	\$4684	\$4869	\$5740

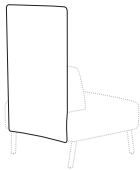

1273/30U Inset 30° Outside Curve Panel - Upholstered

COM Yardage - Panel: 2 Yds.

COM	GR1	GR2	GR3	GR4	GR5	GR6	GR7	GR8	GR9	GR10	LEA
\$1572	\$1672	\$1734	\$1804	\$1871	\$1944	\$2020	\$2095	\$2178	\$2259	\$2349	\$2761

1273/45U Inset 45° Outside Curve Panel - Upholstered

COM Yardage - Panel: 3 Yds.

COM	GR1	GR2	GR3	GR4	GR5	GR6	GR7	GR8	GR9	GR10	LEA
\$1795	\$1913	\$1988	\$2063	\$2141	\$2226	\$2311	\$2398	\$2490	\$2589	\$2687	\$3163

1273/60U Inset 60° Outside Curve Panel - Upholstered

COM Yardage - Panel: 4 Yds.

COM	GR1	GR2	GR3	GR4	GR5	GR6	GR7	GR8	GR9	GR10	LEA
\$2754	\$2939	\$3055	\$3175	\$3298	\$3426	\$3559	\$3700	\$3844	\$3993	\$4153	\$4891

OPTIONS

Add upcharge to list price and code to model number

FR	CAL 133 (TB 133) Fire Retardant per yard	\$118	/yd.
----	--	-------	------

2FO	Two Fabric Option	\$131	
-----	-------------------	-------	--

DIMENSIONS	Outside Slim Arm L/R	Center Slim Arm
Overall Depth:	27"	20"
Overall Width:	2.5"	2.5"
Arm Height:	24"	7"
Qty./Wt.:	1 ea./25 lbs.	1 ea./10 lbs.



MODEL / DESCRIPTION / LIST PRICING

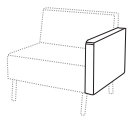

1259L Left Outside Slim Arm

COM Yardage: Total: 1.5 Yds.

COM	GR1	GR2	GR3	GR4	GR5	GR6	GR7	GR8	GR9	GR10	LEA
\$436	\$467	\$487	\$505	\$525	\$545	\$568	\$590	\$612	\$639	\$664	\$784

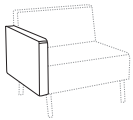

1259R Right Outside Slim Arm

COM Yardage: Total: 1.5 Yds.

COM	GR1	GR2	GR3	GR4	GR5	GR6	GR7	GR8	GR9	GR10	LEA
\$436	\$467	\$487	\$505	\$525	\$545	\$568	\$590	\$612	\$639	\$664	\$784

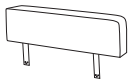

1259C Center Slim Arm

COM Yardage: Total: 1 Yds.

COM	GR1	GR2	GR3	GR4	GR5	GR6	GR7	GR8	GR9	GR10	LEA
\$400	\$472	\$529	\$602	\$656	\$711	\$766	\$819	\$896	\$968	\$1041	\$1205

TABLET SHAPES

Three Tablet Shapes::

Choose from the three shapes shown and specify; A, B or C and left or right (outside tablet) when ordering.

Example: TABF- (A) Left - this would be a fixed shape A tablet on the left side (when seated).

Laminate Top: Tops are 3/4"

Tablet orders of 5 or less have 4 standard laminate colors:

- Wilsonart Black 1595-60
- Wilsonart Montana Walnut 7110K-78
- Formica Brite White 459-58
- Nevamar Silver Alu Metalx MXT003

Edge: 6F Multi-Ply

Solid Surface Top:

Tablet orders of 5 or less have 4 standard Corian colors:

- Bone
- Canyon
- Glacier White
- Silver Grey

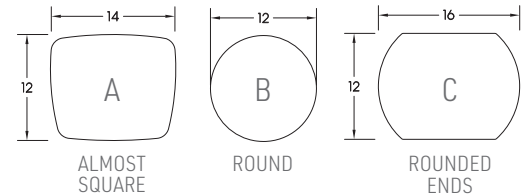

OPTIONS

Add upcharge to list price and code to model number

FR	CAL 133 (TB 133) Fire Retardant per yard	\$118	/yd.	TABR2-()	Removable Tablet (specify A, B or C both arm openings)	\$893	ea. tablet
WAC	Wood Arm Cap (Slim Arm)	\$116	each	LAM5	Non-standard laminate (5 tablets or less)	\$554	ea. tablet
PAC	Poly Arm Cap - Standard Black/Charcoal (Slim Arm)	\$89	each	SST	Solid Surface Tablet Arm - add to tablet option	\$271	ea. tablet
TAB-()	Swivel Tablet (specify A, B or C, left or right arm)	\$653	ea. tablet	SS5	Non-standard Solid Surface (5 tablets or less)	Call For Quote	
TABR1-()	Removable Tablet (specify A, B or C, left or right arm)	\$756	ea. tablet				

DIMENSIONS	Center Box Arm
Overall Depth:	27"
Overall Width:	8"
Arm Height:	24"
Qty./Wt.:	1 ea./25 lbs.

Note: Box arms are only available as center arms



CENTER BOX ARMS

MODEL / DESCRIPTION / LIST PRICING

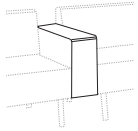

1260C Box Arm

COM Yardage: Total: 2 Yds

COM	GR1	GR2	GR3	GR4	GR5	GR6	GR7	GR8	GR9	GR10	LEA
\$532	\$605	\$660	\$734	\$790	\$844	\$899	\$953	\$1025	\$1099	\$1172	\$1338

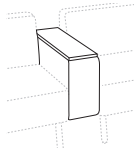

1260W Box Arm plus Table

COM Yardage: Total: 2 Yds

COM	GR1	GR2	GR3	GR4	GR5	GR6	GR7	GR8	GR9	GR10	LEA
\$1108	\$1180	\$1237	\$1309	\$1365	\$1418	\$1473	\$1530	\$1604	\$1676	\$1751	\$1914

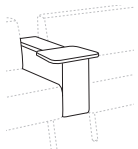

1260T Box Arm plus Fixed Tablet

COM Yardage: Total: 2 Yds

COM	GR1	GR2	GR3	GR4	GR5	GR6	GR7	GR8	GR9	GR10	LEA
\$1043	\$1116	\$1172	\$1246	\$1302	\$1357	\$1410	\$1466	\$1540	\$1611	\$1684	\$1850

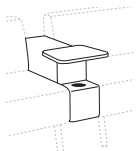

1260TC Box Arm plus Fixed Tablet plus Cup Holder

COM Yardage: Total: 2 Yds

COM	GR1	GR2	GR3	GR4	GR5	GR6	GR7	GR8	GR9	GR10	LEA
\$1483	\$1557	\$1611	\$1684	\$1742	\$1795	\$1850	\$1906	\$1978	\$2053	\$2125	\$2292

Notes:

•Box arm pricing includes ganging

Laminate Top: Tops are 3/4"

Tablet orders of 5 or less have 4 standard laminate colors:

- Wilsonart Black 1595-60
- Wilsonart Montana Walnut 7110K-78
- Formica Brite White 459-58
- Nevamar Silver Alu Metalx MXT003

Edge: 6F Multi-Ply

Solid Surface Top:

Tablet orders of 5 or less have 4 standard Corian colors:

- Bone
- Canyon
- Glacier White
- Silver Grey

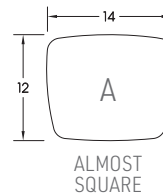

Box Arm Cap tablet available in Shape A only and is fixed

OPTIONS

Add upcharge to list price and code to model number

FR	CAL 133 (TB 133) Fire Retardant per yard	\$118	/yd.	LAM5	Non-standard laminate (5 tablets or less)	\$554	ea. tablet
BWAC	Wood Arm Cap (Box Arm)	\$307	ea.	SST	Solid Surface Tablet Arm - add to tablet option	\$271	ea. tablet
				SS5	Non-standard Solid Surface (5 tablets or less)		Call For Quote

DIMENSIONS	22" Straight	30" Straight	44" Straight
Seat Height:	17"	17"	17"
Overall Depth:	27"	27"	27"
Overall Width:	22"	30"	44"
Qty./Wt.:	1 ea./58 lbs.	1 ea./68 lbs.	1 ea./85 lbs.



44" BACKLESS STRAIGHT UNIT COMPLEMENTED WITH TRENO AND DIXON OCCASIONAL TABLES

MODEL / DESCRIPTION / LIST PRICING



1226 22" W Backless Straight (4 Legs)

COM Yardage: Total: 2 Yds. / Sides: 1 Yds. / Top Front Rear 1 Yds.

COM	GR1	GR2	GR3	GR4	GR5	GR6	GR7	GR8	GR9	GR10	LEA
\$1717	\$1832	\$1942	\$2070	\$2185	\$2313	\$2440	\$2567	\$2697	\$2825	\$2951	\$3137



1228 30" W Backless Straight (4 Legs)

COM Yardage: Total: 2.75 Yds. / Sides: 1 Yds. / Top Front Rear 1.75 Yds.

COM	GR1	GR2	GR3	GR4	GR5	GR6	GR7	GR8	GR9	GR10	LEA
\$2035	\$2229	\$2421	\$2614	\$2807	\$2997	\$3190	\$3384	\$3575	\$3768	\$3960	\$4146



1230 44" W Backless Straight (4 Legs)

COM Yardage: Total: 3 Yds. / Sides: 1 Yds. / Top Front Rear 2 Yds.

COM	GR1	GR2	GR3	GR4	GR5	GR6	GR7	GR8	GR9	GR10	LEA
\$2976	\$3169	\$3361	\$3554	\$3744	\$3938	\$4130	\$4323	\$4518	\$4707	\$4900	\$5084

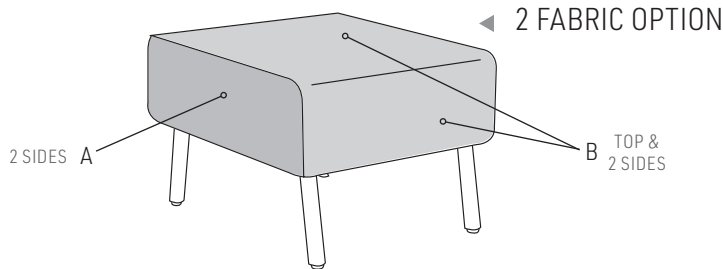

OPTIONS

Add upcharge to list price and code to model number

FR	CAL 133 (TB 133) Fire Retardant per yard	\$118	/yd.	GD1	Ratchet Ganging Device for Soft Seating	\$112	per pair
MB	Moisture Barrier (up to 60" overall width)	\$164	ea.	TABFB- ()	Fixed Blade Tablet (outside or inside, specify (L/R), shape A, B or C)	\$593	ea. tablet
WDL	Metal/Wood Legs	\$45	ea.	LAM5	Non-standard laminate (5 tablets or less)	\$554	ea. tablet
WDL-C	Chrome/Wood Legs	\$79	ea.	SST	Solid Surface Tablet Arm - add to tablet option	\$271	ea. tablet
PC	Polished Chrome Legs	\$45	ea.	SS5	Non-standard Solid Surface (5 tablets or less)	Call For Quote	
2FO	Two Fabric Option	\$131					

DIMENSIONS	30° Curve	45° Curve	60° Curve
Seat Height:	17"	17"	17"
Overall Depth:	27"/28"	27"/29.5"	27"/31.5"
Overall Width:	17"/31"	25.25"/46"	33"/60"
Qty./Wt.:	1 ea./58 lbs.	1 ea./68 lbs.	1 ea./85 lbs.



30° BACKLESS CURVE UNIT

MODEL / DESCRIPTION / LIST PRICING



1232 30° Backless Curve (4 Legs)

COM Yardage: Total: 2.25 Yds. / Sdies: 1 Yds. / Top-Front-Rear: 1.25 Yds

COM	GR1	GR2	GR3	GR4	GR5	GR6	GR7	GR8	GR9	GR10	LEA
\$1802	\$1913	\$2028	\$2155	\$2265	\$2393	\$2523	\$2651	\$2780	\$2909	\$3035	\$3221



1234 45° Backless Curve (4 Legs)

COM Yardage: Total: 3 Yds. / Sdies: 1 Yds. / Top-Front-Rear: 2 Yds

COM	GR1	GR2	GR3	GR4	GR5	GR6	GR7	GR8	GR9	GR10	LEA
\$2614	\$2726	\$2837	\$2966	\$3078	\$3205	\$3335	\$3463	\$3592	\$3718	\$3848	\$4032



1236 60° Backless Curve (5 Legs)

COM Yardage: Total: 4.5 Yds. / Sdies: 1 Yds. / Top-Front-Rear: 3.5 Yds

COM	GR1	GR2	GR3	GR4	GR5	GR6	GR7	GR8	GR9	GR10	LEA
\$2795	\$2909	\$3021	\$3148	\$3262	\$3389	\$3518	\$3646	\$3775	\$3903	\$4030	\$4217

OPTIONS

Add upcharge to list price and code to model number

FR	CAL 133 (TB 133) Fire Retardant per yard	\$118	/yd.
MB	Moisture Barrier (up to 60" overall width)	\$164	ea.
WDL	Metal/Wood Legs	\$45	ea.
WDL-C	Chrome/Wood Legs	\$79	ea.
PC	Polished Chrome Legs	\$45	ea.
2FO	Two Fabric Option	\$131	

GD1	Ratchet Ganging Device for Soft Seating	\$112	per pair
TABFB-()	Fixed Blade Tablet (outside or inside, specify (L/R), shape A, B or C)	\$593	ea. tablet
LAM5	Non-standard laminate (5 tablets or less)	\$554	ea. tablet
SST	Solid Surface Tablet Arm - add to tablet option	\$271	ea. tablet
SS5	Non-standard Solid Surface (5 tablets or less)	Call For Quote	

DIMENSIONS	Quattro
Seat Height:	17"
Overall Depth:	54"
Overall Width:	54"
Overall Height:	17"
Seat Depth:	27"
Qty./Wt.:	1 ea./90 lbs.



QUATTRO

MODEL / DESCRIPTION / LIST PRICING

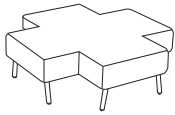

1225 Quattro (8 Legs)

COM Yardage: Total: 6 Yds. / Top: 3 Yds. / Sides: 3 Yds.

COM	GR1	GR2	GR3	GR4	GR5	GR6	GR7	GR8	GR9	GR10	LEA
\$5879	\$6071	\$6264	\$6455	\$6648	\$6840	\$7033	\$7226	\$7417	\$7611	\$7802	\$7987

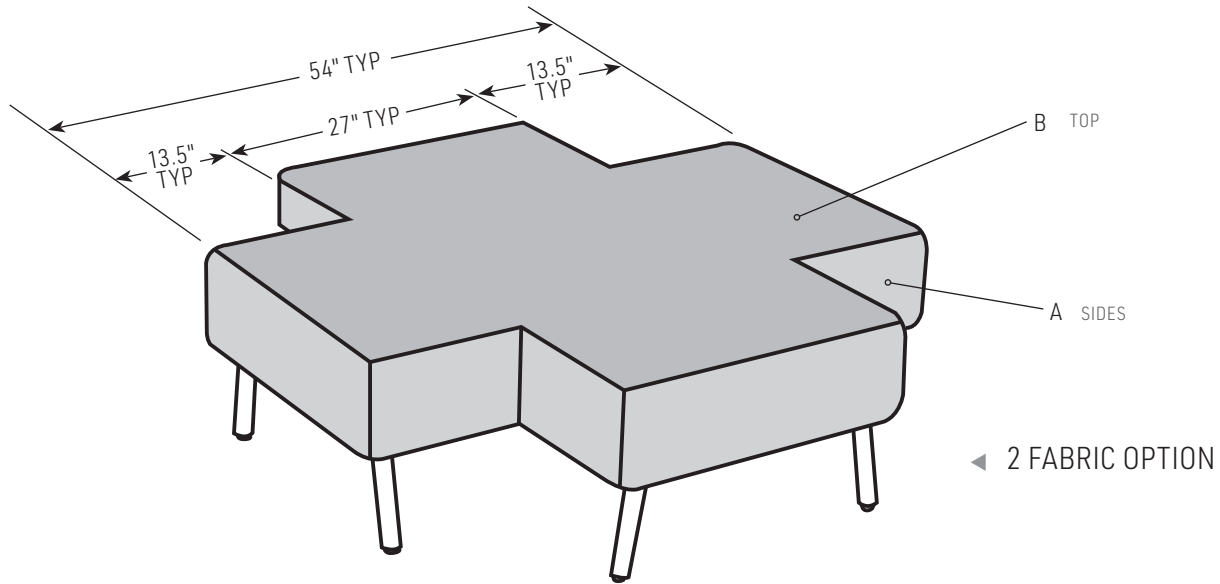

OPTIONS

Add upcharge to list price and code to model number

FR	CAL 133 (TB 133) Fire Retardant per yard	\$118	/yd.	GD1	Ratchet Ganging Device for Soft Seating	\$112	per pair
MB	Moisture Barrier (up to 60" overall width)	\$164	ea.	TABFB (-)	Fixed Blade Tablet (outside or inside, specify (L/R), shape A, B or C)	\$593	ea. tablet
WDL	Metal/Wood Legs	\$45	ea.	LAM5	Non-standard laminate (5 tablets or less)	\$554	ea. tablet
WDL-C	Chrome/Wood Legs	\$79	ea.	SST	Solid Surface Tablet Arm - add to tablet option	\$271	ea. tablet
PC	Polished Chrome Legs	\$45	ea.	SS5	Non-standard Solid Surface (5 tablets or less)	Call For Quote	
2FO	Two Fabric Option	\$131					

Note: Due to it's size, Moisture Barrier is priced at MB60 pricing.

OPTIONS

- CODE: FR - CAL 133 (TB 133) Fire Retardant
- CODE: MB - Moisture Barrier (up to 60" overall width)
- CODE: MB60 - Moisture Barrier (over 60" overall width)
- CODE: PC - Polished Chrome Legs
- CODE: WDL - Metal/Wood Legs. (Specify powder coat and wood color)
- CODE: WDL-C - Chrome/Wood Legs. (Specify wood color)
- CODE: 2FO - Two Fabric Option
- CODE: 3FO - Three Fabric Option
- CODE: PAC-L - Poly Arm Caps
- CODE: WAC-L - Wood Arm Caps
- CODE: BWAC - Wood Arm Caps for Box Arm
- CODE: TAB-() - Swivel Tablet (shape A, B or C, left or right arm)
- CODE: TABR1-() - Removable Tablet (shape A, B or C, left or right arm)
- CODE: TABR2-() - Removable Tablet (shape A, B or C, hardware both arms)
- CODE: LAM5 - Non-standard laminate for 5 or less tablets see options for upcharge
- CODE: SST - Solid Surface Tablet Arm
- CODE: SS5 - Non-standard Solid Surface top for 5 or less tablets

Note: Factory installed power/data available, see accessories online under the 'Products' tab.



SINGLE SEAT LOUNGE WITH OPTIONAL TABLET ARM AND METAL/WOOD LEGS



BARIATRIC LOUNGE

TABLET SHAPES

Three Tablet Shapes::

Choose from the three shapes shown and specify; A, B or C and left or right (outside tablet) when ordering.

Example: TABF-(A) Left - this would be a fixed shape A tablet on the left side (when seated).

Laminate Top: Tops are 3/4"

Tablet orders of 5 or less have 4 standard laminate colors:

- Wilsonart Black 1595-60
- Wilsonart Montana Walnut 7110K-78
- Formica Brite White 459-58
- Nevamar Silver Alu Metalx MXT003

Edge: 6F Multi-Ply

Solid Surface Top:

Tablet orders of 5 or less have 4 standard Corian colors:

- Bone
- Canyon
- Glacier White
- Silver Grey

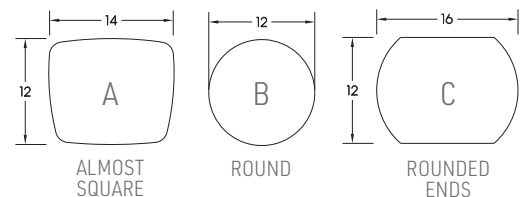

DIMENSIONS	22" Straight	30" Straight	44" Straight
Seat Depth:	21"	21"	21"
Seat Width:	22"	30"	44"
Seat Height:	17"	17"	17"
Overall Depth:	27"	27"	27"
Overall Width:	27"	35"	49"
Overall Height:	30"	30"	30"
Qty./Wt.:	1 ea./75 lbs.	1 ea./90 lbs.	1 ea./110 lbs.



TWO SEAT LOUNGE

MODEL / DESCRIPTION / LIST PRICING



1200L Single Seat Lounge

COM Yardage: Total: 5.5 Yds. / Back: 1.5 Yds. / Seat: 1.5 Yds. / Arms 2.5 Yds.

COM	GR1	GR2	GR3	GR4	GR5	GR6	GR7	GR8	GR9	GR10	LEA
\$3298	\$3492	\$3684	\$3876	\$4066	\$4260	\$4452	\$4645	\$4838	\$5029	\$5224	\$5408



1202L Bariatric Lounge

COM Yardage: Total: 6.5 Yds. / Back: 1.75 Yds. / Seat: 2.25 Yds. / Arms 2.5 Yds.

COM	GR1	GR2	GR3	GR4	GR5	GR6	GR7	GR8	GR9	GR10	LEA
\$4279	\$4523	\$4712	\$4904	\$5096	\$5289	\$5481	\$5675	\$5864	\$6060	\$6253	\$6435

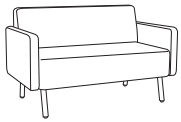

1204L Two Seat Lounge

COM Yardage: Total: 7.5 Yds. / Back: 2.5 Yds. / Seat: 2.5 Yds. / Arms 2.5 Yds.

COM	GR1	GR2	GR3	GR4	GR5	GR6	GR7	GR8	GR9	GR10	LEA
\$4790	\$5029	\$5224	\$5414	\$5607	\$5799	\$5991	\$6183	\$6377	\$6568	\$6763	\$6946

OPTIONS

Add upcharge to list price and code to model number

FR	CA133 Fire Retardant per yard	\$118	/yd.	3FO	Three Fabric Option	\$199	
MB	Moisture Barrier (up to 60" overall width)	\$164	ea.	TAB-()	Swivel Tablet (specify A, B or C, left or right arm)	\$653	ea. tablet
PAC	Poly Arm Cap - Standard Black/Charcoal (Slim Arm)	\$89	ea.	TABR1-()	Removable Tablet (specify A, B or C, left or right arm)	\$756	ea. tablet
WAC	Wood Arm Cap (Slim Arm)	\$116	ea.	TABR2-()	Removable Tablet (specify A, B or C both arm openings)	\$893	ea. tablet
WDL	Metal/Wood Legs	\$45	ea.	LAM5	Non-standard laminate (5 tablets or less)	\$554	ea. tablet
WDL-C	Chrome/Wood Legs	\$79	ea.	SST	Solid Surface Tablet Arm - add to tablet option	\$271	ea. tablet
PC	Polished Chrome Legs	\$45	ea.	SS5	Non-standard Solid Surface (5 tablets or less)		Call For Quote
2FO	Two Fabric Option	\$131					

DIMENSIONS	Single Hideout	Two Seat Hideout
Seat Depth:	20"	20"
Seat Width:	30"	44"
Seat Height:	17"	17"
Overall Depth:	28"	28"
Overall Width:	32"	46"
Overall Height:	48"	48"
Qty./Wt.:	1 ea./150 lbs.	1 ea./175 lbs.



TWO SEAT HIDEOUT WITH 22" BOLSTERS
WOOD LEGS AND DIXON LAPTOP TABLE



HIDEOUT PROFILE VIEW

MODEL / DESCRIPTION / LIST PRICING



1222 Single Hideout (4 Legs)

COM	GR1	GR2	GR3	GR4	GR5	GR6	GR7	GR8	GR9	GR10	LEA
\$5705	\$5854	\$6014	\$6188	\$6346	\$6521	\$6697	\$6872	\$7049	\$7225	\$7436	\$7638

COM Yardage: Seat: 2.75 Yds. / Back: 2 Yds.

Panels Total: 8 Yds. / Outside 4 Yds. / Inside 4 Yds.



1224 Two Seat Hideout (4 Legs)

COM	GR1	GR2	GR3	GR4	GR5	GR6	GR7	GR8	GR9	GR10	LEA
\$7062	\$7276	\$7485	\$7696	\$7905	\$8116	\$8329	\$8539	\$8749	\$8959	\$9171	\$9370

COM Yardage: Seat: 3.75 Yds. / Back: 1.5 Yds.

Panels Total: 9 Yds. / Outside 4.5 Yds. / Inside 4.5 Yds.

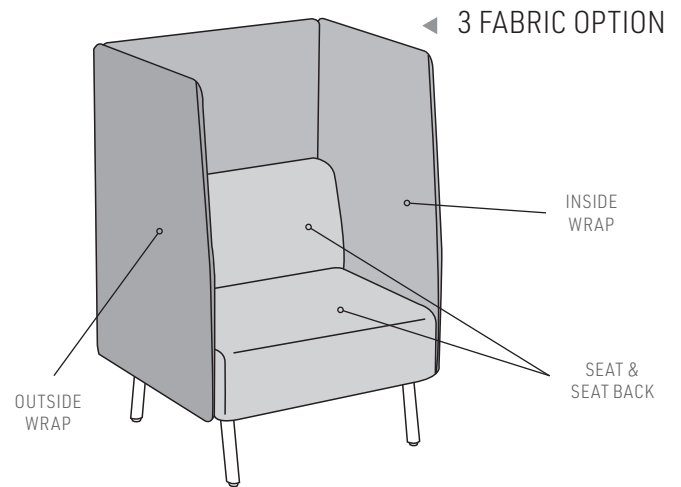
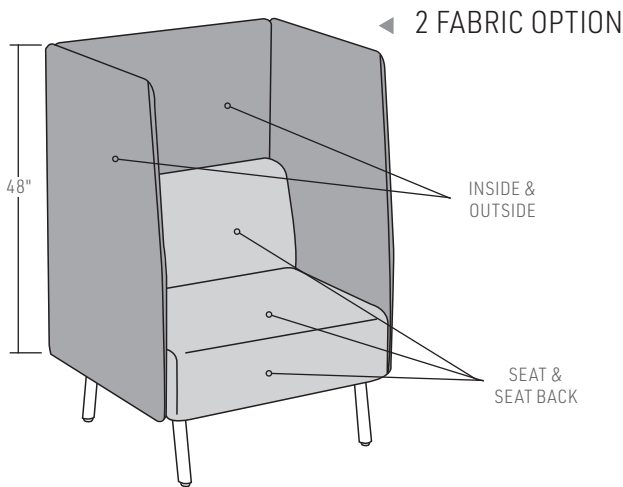

NOTE: 1.5" THICK FINISHED PANEL
SHIPPED COMPLETELY ASSEMBLED

OPTIONS

Add upcharge to list price and code to model number

FR	CAL 133 (TB 133) Fire Retardant per yard	\$118	/yd.	PC	Polished Chrome Legs	\$45	ea.
MB	Moisture Barrier (up to 60" overall width)	\$164	ea.	2FO	Two Fabric Option	\$131	
WDL	Metal/Wood Legs	\$45	ea.	3FO	Three Fabric Option	\$199	
WDL-C	Chrome/Wood Legs	\$79	ea.	GD1	Ratchet Ganging Device for Soft Seating	\$112	per pair

DIMENSIONS	Single Hideout	Two Seat Hideout
Seat Depth:	20"	20"
Seat Width:	30"	44"
Seat Height:	17"	17"
Arm Height:	24.5"	24.5"
Overall Depth:	28"	28"
Overall Width:	40"	54"
Overall Height:	48"	48"
Qty./Wt.:	1 ea./180 lbs.	1 ea./195 lbs.



LAGUNA TWO SEAT HIDEOUT WITH BOX ARM AND OPTIONAL BOX ARM TABLE AND POWER

Laminate Top Note:

- Tops are 3/4" laminate
- Std with edge 6F multi-exposed core

MODEL / DESCRIPTION / LIST PRICING



1222A-(L/R) Single Hideout w/Box Arm (4 Legs)

COM	GR1	GR2	GR3	GR4	GR5	GR6	GR7	GR8	GR9	GR10	LEA
\$6816	\$6946	\$7084	\$7237	\$7374	\$7528	\$7681	\$7834	\$7989	\$8143	\$8328	\$8503

COM Yardage: Seat: 2.25 Yds. / Back: 1.5 Yds. / Box Arms: 2 Yds.
Panels Total: 9 Yds. / Outside 4.5 Yds. / Inside 4.5 Yds.

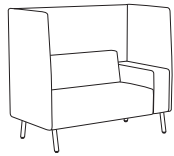

1224A-(L/R) Two Seat Hideout w/Box Arm (4 Legs)

COM	GR1	GR2	GR3	GR4	GR5	GR6	GR7	GR8	GR9	GR10	LEA
\$7398	\$7528	\$7667	\$7821	\$7958	\$8110	\$8265	\$8420	\$8571	\$8725	\$8909	\$9084

COM Yardage: Seat: 2.75 Yds. / Back: 2 Yds. / Box Arms: 2 Yds.
Panels Total: 10 Yds. / Outside 5 Yds. / Inside 5 Yds.

Hideout Box Arm Note:

When sitting, specify right or left arm.

BOX ARM TABLE & ARTICULATING TABLE NOTES

Box Arm Table and Articulating Tablet orders of 5 or less:

Laminate Top: Tops are 3/4"

4 standard laminate colors:

- Wilsonart Black 1595-60
- Wilsonart Montana Walnut 7110K-78
- Formica Brite White 459-58
- Nevamar Silver Alu Metalx MXT003

Edge: 6F Multi-Ply

Solid Surface Top:

Box Arm Table only - 4 standard Corian colors (solid surface):

- Bone
- Canyon
- Glacier White
- Silver Grey

Articulating tablet available in Shape F only (Solid surface not available)

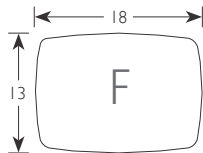

ALMOST RECTANGLE



HIDEOUT BOX ARM SHOWN WITH TABLE AND ARTICULATING TABLET OPTIONS

OPTIONS

Add upcharge to list price and code to model number

FR	CAL 133 (TB 133) Fire Retardant per yard	\$118	/yd.
MB	Moisture Barrier (up to 60" overall width)	\$164	ea.
WDL	Metal/Wood Legs	\$45	ea.
WDL-C	Chrome/Wood Legs	\$79	ea.
PC	Polished Chrome Legs	\$45	ea.
2FO	Two Fabric Option	\$131	
3FO	Three Fabric Option	\$199	
GD1	Ratchet Ganging Device for Soft Seating	\$112	per pair

BWAC	Wood Arm Cap (Box Arm)	\$307	ea.
LAM5	Non-standard laminate (5 tablets or less)	\$554	ea. tablet
SST	Solid Surface Table - add to table option	\$271	ea. tablet
SS5	Non-standard Solid Surface (5 tables or less)	Call For Quote	
HBA-L	Box Arm + Table	\$467	
HBA-T	Box Arm + Articulating Tablet	\$841	
HBA-LT	Box Arm + Table + Articulating Tablet	\$1346	

DIMENSIONS	22" Bolster	30" Bolster	44" Bolster	12"x20" Pillow	16"x16" Pillow
Overall Depth:	6"	6"	6"	4"	4"
Overall Width:	22"	30"	44"	20"	16"
Overall Height:	6"	6"	6"	12"	16"
Qty./Wt.:	1 ea./25 lbs.	1 ea./25 lbs.	1 ea./25 lbs.	1 ea./25 lbs.	1 ea./25 lbs.



LAGUNA TWO SEAT HIDEOUT WITH 44" BOLSTER

MODEL / DESCRIPTION / LIST PRICING



1219-22 22" Round Bolster

COM Yardage: Total: .75 Yds.

COM	GR1	GR2	GR3	GR4	GR5	GR6	GR7	GR8	GR9	GR10	LEA
\$462	\$497	\$515	\$536	\$560	\$582	\$605	\$632	\$653	\$676	\$709	\$835



1219-30 30" Round Bolster

COM Yardage: Total: 1 Yds.

COM	GR1	GR2	GR3	GR4	GR5	GR6	GR7	GR8	GR9	GR10	LEA
\$578	\$617	\$646	\$670	\$699	\$726	\$754	\$784	\$814	\$849	\$883	\$1042



1219-44 44" Round Bolster

COM Yardage: Total: 1.5 Yds.

COM	GR1	GR2	GR3	GR4	GR5	GR6	GR7	GR8	GR9	GR10	LEA
\$739	\$792	\$819	\$854	\$888	\$922	\$961	\$999	\$1040	\$1080	\$1123	\$1328



1220 12" x 20" Rectangle Pillow

COM Yardage: Total: .75 Yds.

COM	GR1	GR2	GR3	GR4	GR5	GR6	GR7	GR8	GR9	GR10	LEA
\$572	\$612	\$638	\$664	\$690	\$718	\$746	\$775	\$806	\$838	\$872	\$1034



1221 16" x 16" Square Pillow

COM Yardage: Total: .75 Yds.

COM	GR1	GR2	GR3	GR4	GR5	GR6	GR7	GR8	GR9	GR10	LEA
\$608	\$649	\$674	\$704	\$731	\$761	\$793	\$820	\$855	\$888	\$925	\$1095

OPTIONS

Add upcharge to list price and code to model number

FR	CAL 133 (TB 133) Fire Retardant per yard	\$118	/yd.	MB	Moisture Barrier (up to 60" overall width)	\$164	ea.
----	--	-------	------	----	--	-------	-----

DIMENSIONS	22" Straight	44" Straight	66" Straight
Overall Depth:	20"	20"	20"
Overall Width:	22"	44"	66"
Overall Height:	17"	17"	17"
Qty./Wt.:	1 ea./58 lbs.	1 ea./68 lbs.	1 ea./85 lbs.



BENCH W/CENTER TABLE



44" BENCH

MODEL / DESCRIPTION / LIST PRICING



1254 22" W Straight Bench (4 Legs)

COM Yardage: Total: 2 Yds. / Sides: 1 Yds. / Top: 1 Yds.

COM	GR1	GR2	GR3	GR4	GR5	GR6	GR7	GR8	GR9	GR10	LEA
\$1508	\$1619	\$1731	\$1859	\$1972	\$2101	\$2229	\$2356	\$2487	\$2614	\$2740	\$2923



1256 44" W Straight Bench (4 Legs)

COM Yardage: Total: 3 Yds. / Sides: 1.5 Yds. / Top: 1.5 Yds.

COM	GR1	GR2	GR3	GR4	GR5	GR6	GR7	GR8	GR9	GR10	LEA
\$2593	\$2785	\$2978	\$3170	\$3362	\$3555	\$3747	\$3940	\$4133	\$4324	\$4519	\$4701

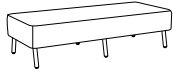

1258 66" W Straight Bench (6 Legs)

COM Yardage: Total: 4 Yds. / Sides: 2 Yds. / Top: 2 Yds.

COM	GR1	GR2	GR3	GR4	GR5	GR6	GR7	GR8	GR9	GR10	LEA
\$3027	\$3218	\$3411	\$3603	\$3796	\$3990	\$4181	\$4374	\$4566	\$4757	\$4949	\$5135

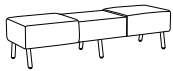

1258T 66" W Straight Bench with Center **LAMINATE** Table (6 Legs)

COM Yardage: Total: 4 Yds. / Sides: 2 Yds. / Top: 2 Yds.

COM	GR1	GR2	GR3	GR4	GR5	GR6	GR7	GR8	GR9	GR10	LEA
\$3235	\$3427	\$3619	\$3813	\$4005	\$4198	\$4387	\$4580	\$4772	\$4966	\$5158	\$5342

1258V 66" W Straight Bench with Center **VENEER** Table (6 Legs)

COM	GR1	GR2	GR3	GR4	GR5	GR6	GR7	GR8	GR9	GR10	LEA
\$3399	\$3592	\$3783	\$3974	\$4170	\$4360	\$4553	\$4745	\$4937	\$5129	\$5323	\$5507

OPTIONS

Add upcharge to list price and code to model number

FR	CAL 133 (TB 133) Fire Retardant per yard	\$118	/yd.
MB	Moisture Barrier (up to 60" overall width)	\$164	ea.
MB60	Moisture Barrier - (over 60" overall width)	\$262	ea.
PC	Polished Chrome Legs	\$45	ea.

WDL	Metal/Wood Legs	\$45	ea.
WDL-C	Chrome/Wood Legs	\$79	ea.
2FO	Two Fabric Option	\$131	

DIMENSIONS	24" Dia Ottoman	30" Dia Ottoman	36" Dia Ottoman	42" Dia Ottoman
Overall Depth:	24"	30"	36"	42"
Overall Width:	24"	30"	36"	42"
Overall Height:	16"	16"	16"	16"
Qty./Wt.:	1 ea./20 lbs.	1 ea./29 lbs.	1 ea./42 lbs.	1 ea./59 lbs.



ROUND OTTOMAN 24" DIAMETER

MODEL / DESCRIPTION / LIST PRICING



1238 24" Diameter Ottoman (4 Legs)

COM Yardage: Total: 2.25 Yds. / Sides: 1.5 Yds. / Top: .75 Yds.

COM	GR1	GR2	GR3	GR4	GR5	GR6	GR7	GR8	GR9	GR10	LEA
\$1587	\$1780	\$1972	\$2166	\$2356	\$2549	\$2740	\$2936	\$3126	\$3318	\$3511	\$3695



1240 30" Diameter Ottoman (4 Legs)

COM Yardage: Total: 2.75 Yds. / Sides: 1.75 Yds. / Top: 1 Yds.

COM	GR1	GR2	GR3	GR4	GR5	GR6	GR7	GR8	GR9	GR10	LEA
\$1883	\$2073	\$2265	\$2459	\$2651	\$2845	\$3035	\$3227	\$3421	\$3614	\$3804	\$3991

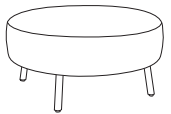

1242 36" Diameter Ottoman (4 Legs)

COM Yardage: Total: 3.25 Yds. / Sides: 2 Yds. / Top: 1.25 Yds.

COM	GR1	GR2	GR3	GR4	GR5	GR6	GR7	GR8	GR9	GR10	LEA
\$2059	\$2249	\$2442	\$2636	\$2827	\$3021	\$3213	\$3404	\$3597	\$3790	\$3981	\$4168

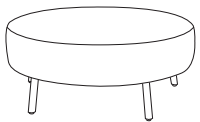

1244 42" Diameter Ottoman (5 Legs)

COM Yardage: Total: 3.75 Yds. / Sides: 2.25 Yds. / Top: 1.5 Yds.

COM	GR1	GR2	GR3	GR4	GR5	GR6	GR7	GR8	GR9	GR10	LEA
\$2507	\$2700	\$2892	\$3085	\$3274	\$3470	\$3663	\$3852	\$4046	\$4239	\$4432	\$4616

OPTIONS

Add upcharge to list price and code to model number

FR	CAL 133 (TB 133) Fire Retardant per yard	\$118	/yd.
MB	Moisture Barrier (up to 60" overall width)	\$164	ea.
PC	Polished Chrome Legs	\$45	ea.

WDL	Metal/Wood Legs	\$45	ea.
WDL-C	Chrome/Wood Legs	\$79	ea.
2FO	Two Fabric Option	\$131	

DIMENSIONS	18" Dia Ottoman	24" Dia Ottoman	30" Dia Ottoman	36" Dia Ottoman	42" Dia Ottoman
Overall Depth:	18"	24"	30"	36"	42"
Overall Width:	18"	24"	30"	36"	42"
Overall Height:	16"	16"	16"	16"	16"
Qty./Wt.:	1 ea./14 lbs.	1 ea./22 lbs.	1 ea./35 lbs.	1 ea./51 lbs.	1 ea./69 lbs.



ROUND OTTOMAN WITH OPTIONAL CASTERS

Note: glides are installed

MODEL / DESCRIPTION / LIST PRICING

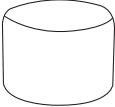
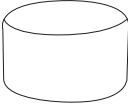
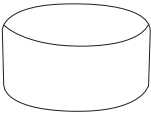
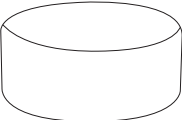
	1237NL 18" Diameter Ottoman No Legs (4 - 2" Casters Needed)	COM Yardage: Total: 2.25 Yds. / Top: .75 Yds. / Sides: 1.5 Yds.										
	COM GR1 GR2 GR3 GR4 GR5 GR6 GR7 GR8 GR9 GR10 LEA	\$1288	\$1481	\$1675	\$1865	\$2059	\$2249	\$2442	\$2636	\$2827	\$3021	\$3213
	1238NL 24" Diameter Ottoman No Legs (4 casters needed)	COM Yardage: Total: 2.25 Yds. / Top: .75 Yds. / Sides: 1.5 Yds.										
	COM GR1 GR2 GR3 GR4 GR5 GR6 GR7 GR8 GR9 GR10 LEA	\$1465	\$1658	\$1851	\$2042	\$2236	\$2428	\$2618	\$2812	\$3004	\$3197	\$3389
	1240NL 30" Diameter Ottoman No Legs (4 casters needed)	COM Yardage: Total: 2.75 Yds. / Top: 1 Yds. / Sides: 1.75 Yds.										
	COM GR1 GR2 GR3 GR4 GR5 GR6 GR7 GR8 GR9 GR10 LEA	\$1737	\$1931	\$2121	\$2315	\$2507	\$2700	\$2892	\$3085	\$3274	\$3470	\$3663
	1242NL 36" Diameter Ottoman No Legs (4 casters needed)	COM Yardage: Total: 4.25 Yds. / Top: 1.25 Yds. / Sides: 3 Yds.										
	COM GR1 GR2 GR3 GR4 GR5 GR6 GR7 GR8 GR9 GR10 LEA	\$1901	\$2091	\$2285	\$2476	\$2670	\$2863	\$3053	\$3246	\$3439	\$3631	\$3824
	1244NL 42" Diameter Ottoman No Legs (5 casters needed)	COM Yardage: Total: 4.5 Yds. / Top: 1.5 Yds. / Sides: 3 Yds.										
	COM GR1 GR2 GR3 GR4 GR5 GR6 GR7 GR8 GR9 GR10 LEA	\$2315	\$2507	\$2700	\$2892	\$3085	\$3274	\$3470	\$3663	\$3852	\$4046	\$4239

OPTIONS

Add upcharge to list price and code to model number

FR	CAL 133 (TB 133) Fire Retardant per yard	\$118	/yd.
MB	Moisture Barrier (up to 60" overall width)	\$164	ea.
2FO	Two Fabric Option	\$131	

CAS2	2" Locking Casters - Black (18" size Only)	\$28	ea.
CAS3	3" Locking Casters - Black (not available on 18" size)	\$34	ea.

DIMENSIONS	24" Square	30" Square	36" Square	42" Square
Overall Depth:	24"	30"	36"	42"
Overall Width:	24"	30"	36"	42"
Overall Height:	16"	16"	16"	16"
Qty./Wt.:	1 ea./24 lbs.	1 ea./37 lbs.	1 ea./54 lbs.	1 ea./75 lbs.



30" ALMOST SQUARE OTTOMAN

MODEL / DESCRIPTION / LIST PRICING



1246 24" Almost Square Ottoman (4 Legs)

COM Yardage: Total: 2 Yds. / Sides: 1 Yds. / Top: 1 Yds.

COM	GR1	GR2	GR3	GR4	GR5	GR6	GR7	GR8	GR9	GR10	LEA
\$1637	\$1826	\$2020	\$2211	\$2406	\$2596	\$2791	\$2982	\$3173	\$3364	\$3557	\$3742



1248 30" Almost Square Ottoman (4 Legs)

COM Yardage: Total: 2.5 Yds. / Sides: 1.5 Yds. / Top: 1 Yds.

COM	GR1	GR2	GR3	GR4	GR5	GR6	GR7	GR8	GR9	GR10	LEA
\$1902	\$2095	\$2286	\$2478	\$2671	\$2864	\$3057	\$3247	\$3440	\$3636	\$3826	\$4009



1250 36" Almost Square Ottoman (4 Legs)

COM Yardage: Total: 3 Yds. / Sides: 1.75 Yds. / Top: 1.25 Yds.

COM	GR1	GR2	GR3	GR4	GR5	GR6	GR7	GR8	GR9	GR10	LEA
\$2081	\$2273	\$2466	\$2656	\$2849	\$3041	\$3235	\$3427	\$3619	\$3813	\$4005	\$4186

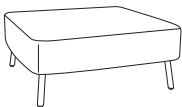

1252 42" Almost Square Ottoman (4 Legs)

COM Yardage: Total: 3.25 Yds. / Sides: 1.75 Yds. / Top: 1.5 Yds.

COM	GR1	GR2	GR3	GR4	GR5	GR6	GR7	GR8	GR9	GR10	LEA
\$2551	\$2744	\$2938	\$3129	\$3320	\$3513	\$3706	\$3900	\$4092	\$4282	\$4476	\$4661

OPTIONS

Add upcharge to list price and code to model number

FR	CAL 133 (TB 133) Fire Retardant per yard	\$118	/yd.
MB	Moisture Barrier (up to 60" overall width)	\$164	ea.
PC	Polished Chrome Legs	\$45	ea.

WDL	Metal/Wood Legs	\$45	ea.
WDL-C	Chrome/Wood Legs	\$79	ea.
2FO	Two Fabric Option	\$131	

DIMENSIONS	18" Square	24" Square	30" Square	36" Square	42" Square	48" Square
Overall Depth:	18"	24"	30"	36"	42"	48"
Overall Width:	18"	24"	30"	36"	42"	48"
Overall Height:	16"	16"	16"	16"	16"	16"
Qty./Wt.:	1 ea./17 lbs.	1 ea./29 lbs.	1 ea./45 lbs.	1 ea./65 lbs.	1 ea./88 lbs.	1 ea./113 lbs.

Note: glides are installed



24" OTTOMAN WITH OPTIONAL
TABLET ARMS & CASTERS

MODEL / DESCRIPTION / LIST PRICING

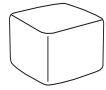

1245NL 18" Almost Square Ottoman No Legs (4 - 2" Casters Needed)

COM Yardage: Total: 2.25 Yds. / Top: .75 Yds. / Sides: 1.5 Yds.

COM	GR1	GR2	GR3	GR4	GR5	GR6	GR7	GR8	GR9	GR10	LEA
\$1328	\$1520	\$1712	\$1906	\$2098	\$2291	\$2480	\$2674	\$2866	\$3059	\$3252	\$3437

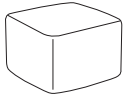

1246NL 24" Almost Square Ottoman No Legs (4 casters needed)

COM Yardage: Total: 2.5 Yds. / Top: .75 Yds. / Sides: 1.75 Yds.

COM	GR1	GR2	GR3	GR4	GR5	GR6	GR7	GR8	GR9	GR10	LEA
\$1509	\$1702	\$1892	\$2085	\$2279	\$2471	\$2663	\$2856	\$3049	\$3241	\$3434	\$3616

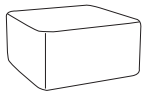

1248NL 30" Almost Square Ottoman No Legs (4 casters needed)

COM Yardage: Total: 3.5 Yds. / Top: 1 Yds. / Sides: 2.5 Yds.

COM	GR1	GR2	GR3	GR4	GR5	GR6	GR7	GR8	GR9	GR10	LEA
\$1756	\$1945	\$2140	\$2332	\$2524	\$2717	\$2910	\$3099	\$3294	\$3486	\$3679	\$3863

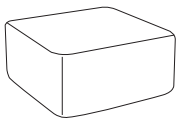

1250NL 36" Almost Square Ottoman No Legs (4 casters needed)

COM Yardage: Total: 4 Yds. / Top: 1.25 Yds. / Sides: 2.75 Yds.

COM	GR1	GR2	GR3	GR4	GR5	GR6	GR7	GR8	GR9	GR10	LEA
\$1920	\$2114	\$2304	\$2497	\$2689	\$2882	\$3076	\$3267	\$3461	\$3651	\$3845	\$4028



1252NL 42" Almost Square Ottoman No Legs (4 casters needed)

COM Yardage: Total: 4.5 Yds. / Top: 1.5 Yds. / Sides: 3 Yds.

COM	GR1	GR2	GR3	GR4	GR5	GR6	GR7	GR8	GR9	GR10	LEA
\$2355	\$2548	\$2739	\$2935	\$3124	\$3317	\$3510	\$3703	\$3894	\$4085	\$4277	\$4463

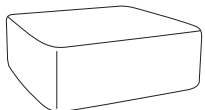

1254NL 48" Almost Square Ottoman No Legs (4 casters needed)

COM Yardage: Total: 5.25 Yds. / Top: 1.75 Yds. / Sides: 3.5 Yds.

COM	GR1	GR2	GR3	GR4	GR5	GR6	GR7	GR8	GR9	GR10	LEA
\$3172	\$3341	\$3510	\$3676	\$3845	\$4014	\$4181	\$4349	\$4518	\$4684	\$4854	\$5014

OPTIONS

Add upcharge to list price and code to model number

FR	CAL 133 (TB 133) Fire Retardant per yard	\$118	/yd.
MB	Moisture Barrier (up to 60" overall width)	\$164	ea.
2FO	Two Fabric Option	\$128	
CAS2	2" Locking Casters - Black (18" size Only)	\$28	ea.
CAS3	3" Locking Casters - Black (not available on 18" size)	\$34	ea.

TABFB-()	Fixed Blade Tablet (outside or inside, specify (L/R), shape A, B or C)	\$593	ea. tablet
LAM5	Non-standard laminate (5 tablets or less)	\$554	ea. tablet
SST	Solid Surface Tablet Arm - add to tablet option	\$271	
SS5	Non-standard Solid Surface (5 tablets or less)	Call For Quote	

DIMENSIONS	24" Dia	30" Dia	36" Dia	42" Dia
Overall Depth:	24"	30"	36"	42"
Overall Width:	24"	30"	36"	42"
Overall Height:	17"	17"	17"	17"
Qty./Wt.:	1 ea./20 lbs.	1 ea./29 lbs.	1 ea./42 lbs.	1 ea./59 lbs.



30" DIAMETER OCCASIONAL TABLE

Laminate Top Note:

- Tops are 3/4" laminate
- Std with 4B multi-exposed core

MODEL / DESCRIPTION / LIST PRICING



1238/T 24" Diameter Occasional Table (4 Legs)

COM Yardage: Total: 1.5 Yds.

COM	GR1	GR2	GR3	GR4	GR5	GR6	GR7	GR8	GR9	GR10	LEA
\$2551	\$2735	\$2915	\$3099	\$3284	\$3467	\$3651	\$3832	\$4017	\$4200	\$4383	\$4559



1240/T 30" Diameter Occasional Table (4 Legs)

COM Yardage: Total: 1.75 Yds.

COM	GR1	GR2	GR3	GR4	GR5	GR6	GR7	GR8	GR9	GR10	LEA
\$3042	\$3225	\$3407	\$3591	\$3776	\$3959	\$4140	\$4323	\$4508	\$4691	\$4874	\$5050

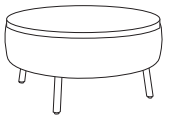

1242/T 36" Diameter Occasional Table (4 Legs)

COM Yardage: Total: 2 Yds.

COM	GR1	GR2	GR3	GR4	GR5	GR6	GR7	GR8	GR9	GR10	LEA
\$3615	\$3799	\$3980	\$4165	\$4348	\$4532	\$4714	\$4898	\$5080	\$5264	\$5447	\$5622

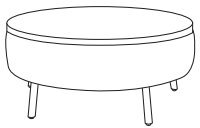

1244/T 42" Diameter Occasional Table (5 Legs)

COM Yardage: Total: 2.25 Yds.

COM	GR1	GR2	GR3	GR4	GR5	GR6	GR7	GR8	GR9	GR10	LEA
\$4566	\$4747	\$4931	\$5115	\$5299	\$5481	\$5664	\$5848	\$6031	\$6213	\$6397	\$6572

OPTIONS

Add upcharge to list price and code to model number

FR	CAL 133 (TB 133) Fire Retardant per yard	\$118	/yd.
PC	Polished Chrome Legs	\$45	ea.

WDL	Metal/Wood Legs	\$45	ea.
WDL-C	Chrome/Wood Legs	\$79	ea.

DIMENSIONS	18" Dia	24" Dia	30" Dia	36" Dia	42" Dia
Overall Depth:	18"	24"	30"	36"	42"
Overall Width:	18"	24"	30"	36"	42"
Overall Height:	17"	17"	17"	17"	17"
Qty./Wt.:	1 ea./14 lbs.	1 ea./22 lbs.	1 ea./35 lbs.	1 ea./51 lbs.	1 ea./69 lbs.



ROUND OCCASIONAL TABLE WITH NO LEGS

Laminate Top Note:

- Tops are 3/4" laminate
- Std with 6F multi-exposed core

Note: glides are installed

MODEL / DESCRIPTION / LIST PRICING



1237NL/T 18" Diameter Occasional Table No Legs (4 - 2" Casters Needed)

COM Yardage: Total: 1.5 Yds.

COM	GR1	GR2	GR3	GR4	GR5	GR6	GR7	GR8	GR9	GR10	LEA
\$2214	\$2398	\$2580	\$2763	\$2948	\$3130	\$3315	\$3496	\$3679	\$3863	\$4046	\$4220

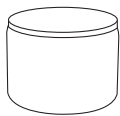

1238NL/T 24" Diameter Occasional Table No Legs (4 casters needed)

COM Yardage: Total: 2 Yds.

COM	GR1	GR2	GR3	GR4	GR5	GR6	GR7	GR8	GR9	GR10	LEA
\$2435	\$2618	\$2802	\$2984	\$3166	\$3352	\$3535	\$3716	\$3900	\$4083	\$4268	\$4442

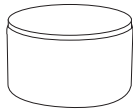

1240NL/T 30" Diameter Occasional Table No Legs (4 casters needed)

COM Yardage: Total: 2.25 Yds.

COM	GR1	GR2	GR3	GR4	GR5	GR6	GR7	GR8	GR9	GR10	LEA
\$2902	\$3088	\$3271	\$3453	\$3638	\$3820	\$4005	\$4186	\$4369	\$4554	\$4736	\$4912



1242NL/T 36" Diameter Occasional Table No Legs (4 casters needed)

COM Yardage: Total: 2.5 Yds.

COM	GR1	GR2	GR3	GR4	GR5	GR6	GR7	GR8	GR9	GR10	LEA
\$3465	\$3647	\$3831	\$4014	\$4198	\$4379	\$4564	\$4747	\$4930	\$5113	\$5297	\$5471

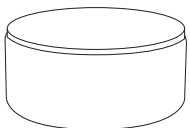

1244NL/T 42" Diameter Occasional Table No Legs (5 casters needed)

COM Yardage: Total: 3 Yds.

COM	GR1	GR2	GR3	GR4	GR5	GR6	GR7	GR8	GR9	GR10	LEA
\$4383	\$4566	\$4747	\$4931	\$5115	\$5299	\$5481	\$5664	\$5848	\$6031	\$6213	\$6391

OPTIONS

Add upcharge to list price and code to model number

FR	CAL 133 (TB 133) Fire Retardant per yard	\$118	/yd.
----	--	-------	------

CAS2	2" Black Casters (18" size Only)	\$28	ea.
CAS3	3" Black Casters (not available on 18" size)	\$34	ea.

DIMENSIONS	24" Square	30" Square	36" Square	42" Square
Overall Depth:	24"	30"	36"	42"
Overall Width:	24"	30"	36"	42"
Overall Height:	17"	17"	17"	17"
Qty./Wt.:	1 ea./24 lbs.	1 ea./37 lbs.	1 ea./54 lbs.	1 ea./75 lbs.

Laminate Top Note:

- Tops are 3/4" laminate
- Std with 4B multi-exposed core



30" ALMOST SQUARE OCCASIONAL TABLE

MODEL / DESCRIPTION / LIST PRICING



1246/T 24" Almost Square Occasional Table (4 Legs)

COM Yardage: Total: 1 Yds.

COM	GR1	GR2	GR3	GR4	GR5	GR6	GR7	GR8	GR9	GR10	LEA
\$2657	\$2842	\$3024	\$3208	\$3390	\$3574	\$3757	\$3941	\$4126	\$4307	\$4490	\$4666



1248/T 30" Almost Square Occasional Table (4 Legs)

COM Yardage: Total: 1.5 Yds.

COM	GR1	GR2	GR3	GR4	GR5	GR6	GR7	GR8	GR9	GR10	LEA
\$3105	\$3289	\$3473	\$3655	\$3838	\$4021	\$4204	\$4387	\$4571	\$4753	\$4937	\$5113



1250/T 36" Almost Square Occasional Table (4 Legs)

COM Yardage: Total: 1.75 Yds.

COM	GR1	GR2	GR3	GR4	GR5	GR6	GR7	GR8	GR9	GR10	LEA
\$3691	\$3873	\$4058	\$4240	\$4422	\$4608	\$4790	\$4975	\$5157	\$5338	\$5523	\$5698

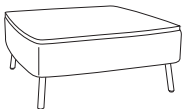

1252/T 42" Almost Square Occasional Table (4 Legs)

COM Yardage: Total: 1.75 Yds.

COM	GR1	GR2	GR3	GR4	GR5	GR6	GR7	GR8	GR9	GR10	LEA
\$4684	\$4865	\$5051	\$5233	\$5417	\$5600	\$5783	\$5968	\$6149	\$6332	\$6517	\$6691

OPTIONS

Add upcharge to list price and code to model number

FR	CAL 133 (TB 133) Fire Retardant per yard	\$118	/yd.
PC	Polished Chrome Legs	\$45	ea.

WDL	Metal/Wood Legs	\$45	ea.
WDL-C	Chrome/Wood Legs	\$79	ea.

DIMENSIONS	18" Square	24" Square	30" Square	36" Square	42" Square
Overall Depth:	18"	24"	30"	36"	42"
Overall Width:	18"	24"	30"	36"	42"
Overall Height:	17"	17"	17"	17"	17"
Qty./Wt.:	1 ea./17 lbs.	1 ea./29 lbs.	1 ea./45 lbs.	1 ea./65 lbs.	1 ea./88 lbs.

Laminate Top Note:

- Tops are 3/4" laminate
- Std with 6F multi-exposed core

Note: glides are installed



30" SQUARE OCCASIONAL TABLE
WITH NO LEGS

MODEL / DESCRIPTION / LIST PRICING

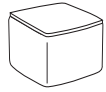

1245NL/T 18" Almost Square Occasional Table - No Legs (4 - 2" Casters Needed)

COM Yardage: Total: 1.5 Yds.

COM	GR1	GR2	GR3	GR4	GR5	GR6	GR7	GR8	GR9	GR10	LEA
\$2326	\$2509	\$2691	\$2875	\$3060	\$3243	\$3426	\$3608	\$3793	\$3975	\$4158	\$4333

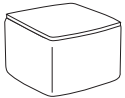

1246NL/T 24" Almost Square Occasional Table - No Legs (4 casters needed)

COM Yardage: Total: 1.75 Yds.

COM	GR1	GR2	GR3	GR4	GR5	GR6	GR7	GR8	GR9	GR10	LEA
\$2537	\$2720	\$2904	\$3087	\$3270	\$3453	\$3638	\$3821	\$4002	\$4186	\$4369	\$4544

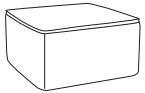

1248NL/T 30" Almost Square Occasional Table - No Legs (4 casters needed)

COM Yardage: Total: 2.5 Yds.

COM	GR1	GR2	GR3	GR4	GR5	GR6	GR7	GR8	GR9	GR10	LEA
\$2967	\$3149	\$3335	\$3517	\$3698	\$3882	\$4066	\$4248	\$4433	\$4615	\$4800	\$4974

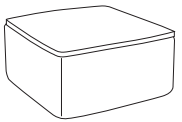

1250NL/T 36" Almost Square Occasional Table - No Legs (4 casters needed)

COM Yardage: Total: 2.75 Yds.

COM	GR1	GR2	GR3	GR4	GR5	GR6	GR7	GR8	GR9	GR10	LEA
\$3536	\$3722	\$3904	\$4087	\$4270	\$4453	\$4638	\$4820	\$5003	\$5187	\$5370	\$5545

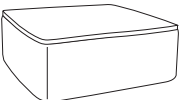

1252NL/T 42" Almost Square Occasional Table - No Legs (4 casters needed)

COM Yardage: Total: 3 Yds.

COM	GR1	GR2	GR3	GR4	GR5	GR6	GR7	GR8	GR9	GR10	LEA
\$4498	\$4680	\$4862	\$5048	\$5230	\$5412	\$5595	\$5778	\$5961	\$6146	\$6328	\$6504

OPTIONS

Add upcharge to list price and code to model number

FR	CAL 133 (TB 133) Fire Retardant per yard	\$118	/yd.
----	--	-------	------

CAS2	2" Black Casters (18" size Only)	\$28	ea.
CAS3	3" Black Casters (not available on 18" size)	\$34	ea.

